

GE Consumer & Industrial
Power Protection

Wiring devices

Switches and socket-outlets



GE imagination at work

Wiring devices

Switches and socket-outlets **A**

Plugs and socket-outlets 2.5A-32A **B**

Bells / Cable clamps / Telecommunication **C**

Junction boxes **D**

Numerical index **X**



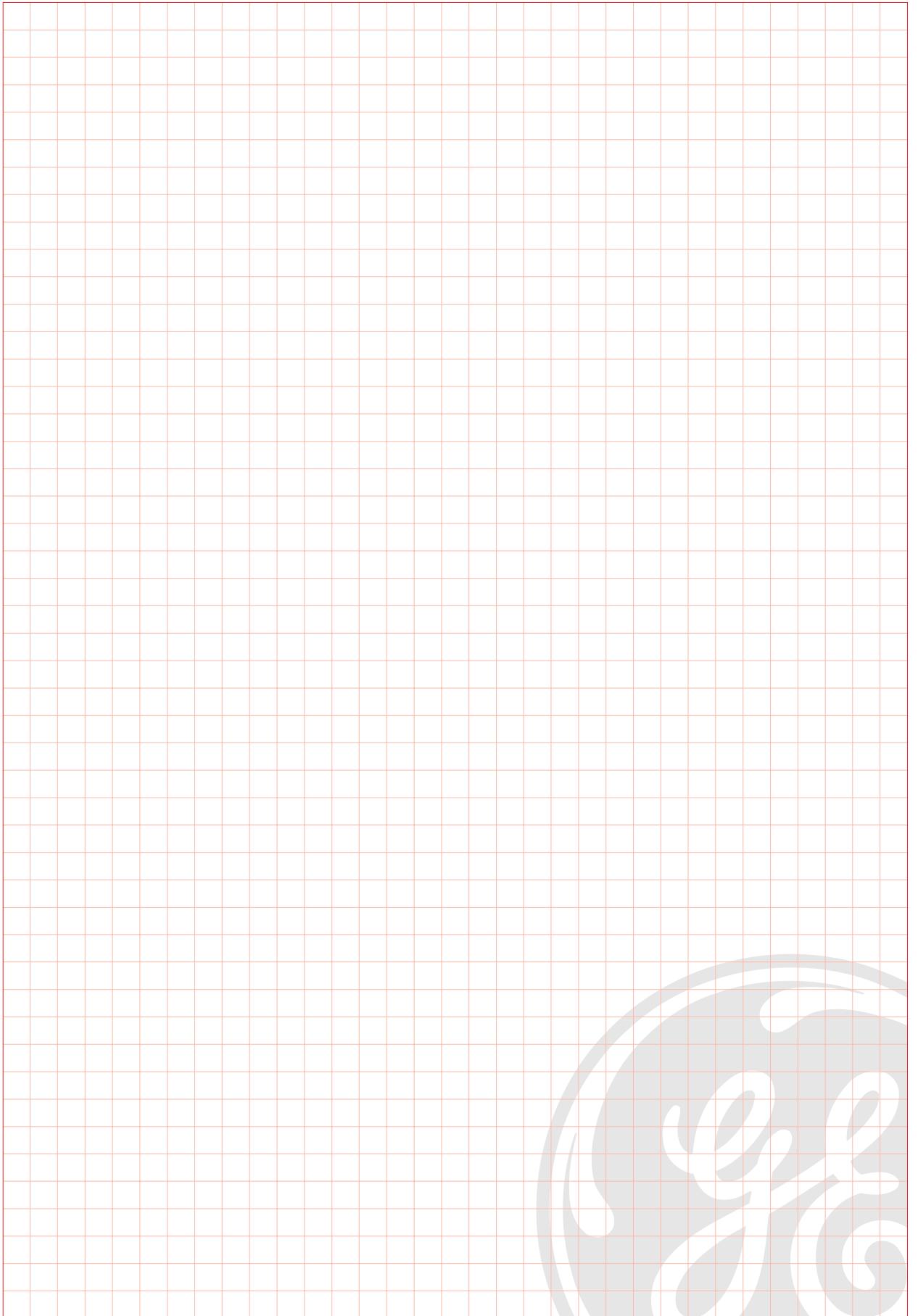

Switches and socket-outlets **A**

- A.2 **SintraPlus**
 - Flush mounting
- A.2 Advantages
- A.7 Basic range
- A.13 Coloured range
- A.21 Metallic range

Plugs and socket-outlets 2.5A-32A **B**

- A.26 **Sintra 65**
 - Outdoor applications

Bells / Cable clamps / Telecommunication **C**

- A.28 **Porto**
 - Monoblock system

- A.30 **Douro**
 - Surface mounting

- A.32 Compliance with standards
- A.33 Wiring diagrams and dimensions

Junction boxes **D**

Numerical index **X**



Switching mechanisms

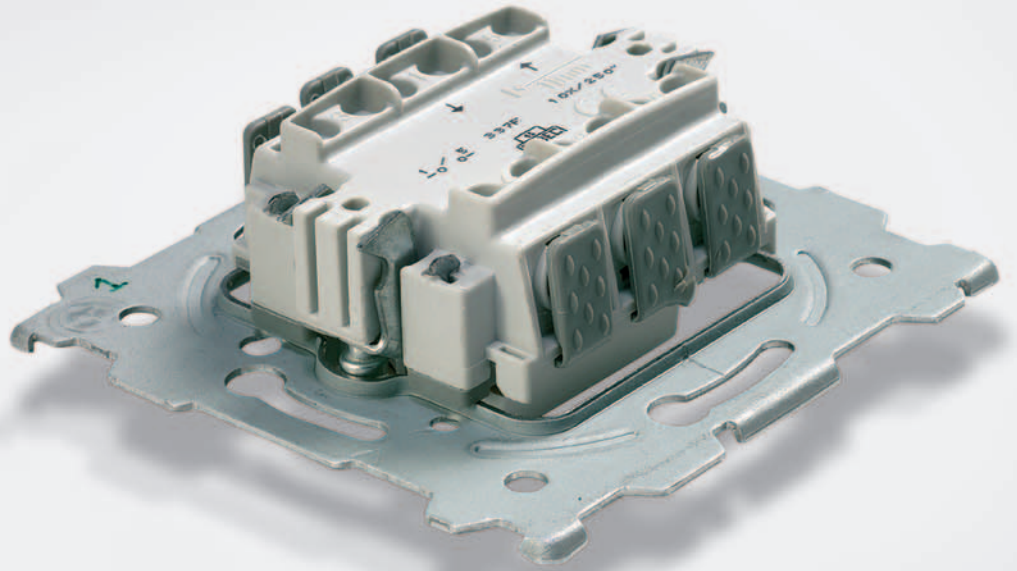

Terminals

Improved wire pull-out force

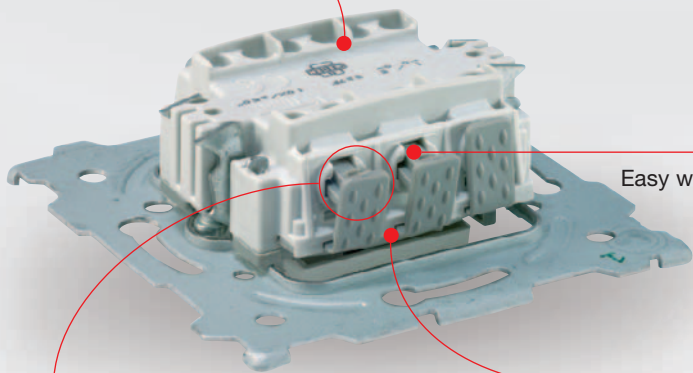

Easy wire (de)connection

Rib holds wire-release button in position when terminal not in use

Clear indication of terminal-in-use

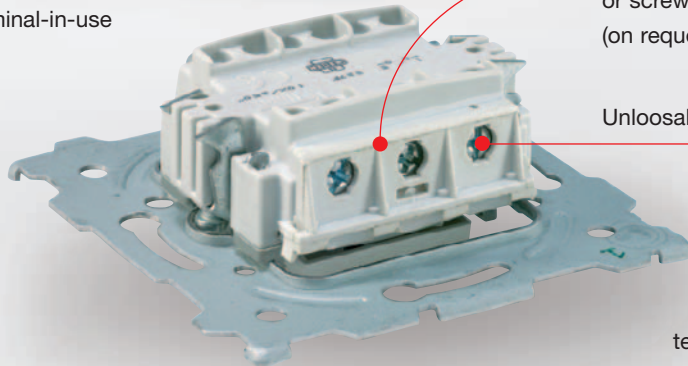

Choice of snap-fit or screw-terminals (on request)

Unloosable screws

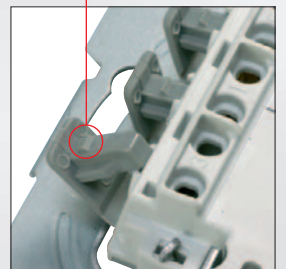

Clearly moulded-in terminal denomination



Two 2.5mm² wires per terminal for easy daisy-chaining

Fully integrated claws

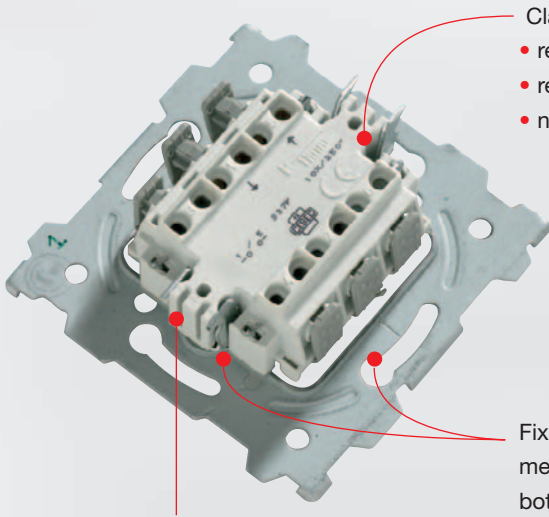

- Claws fully integrated inside the mechanism
- reduce risk of getting injured during handling
- reduced space required behind the switch
- nut and elastic spring no longer required

Adequate claw-guidance avoids claw from spinning

Fixation of the mechanism possible by both screws and claws

Claws fully deploy in 3 turns

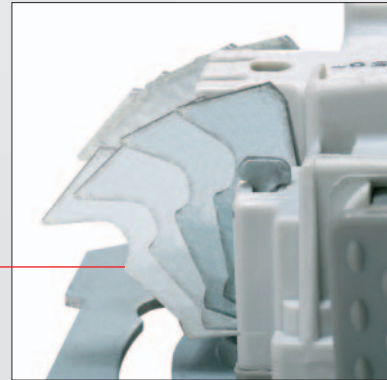

Functional metallic frame

Rigid and high quality metallic frames for guaranteed easy installation

No sharp edges

Anti-corrosion surface treatment

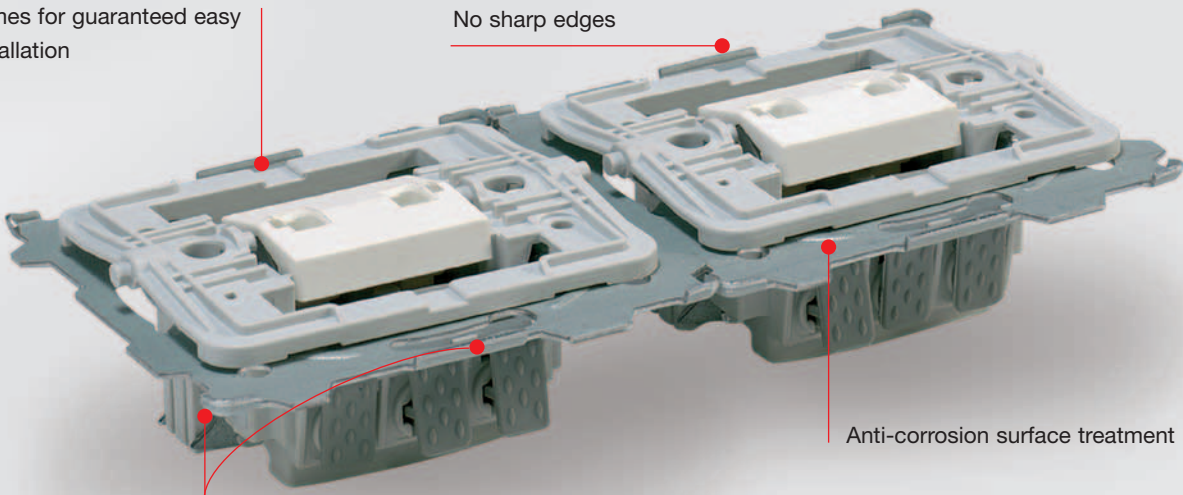

Bended edges and corners avoid mis-alignment or overlapped mounting

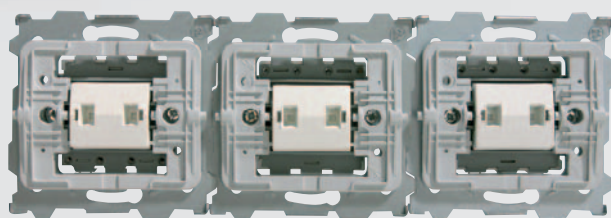
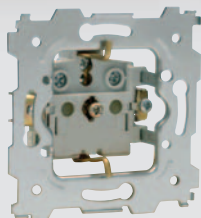

Perfect line-up in horizontal and vertical multi-gang setup



Rockers with new intermediate piece

Single and double rockers, with or without light diffuser, with or without function symbol indication.

Broad range of 1, 2 and 3 gang horizontal and vertical frames

High quality switching mechanism designed to last a lifetime

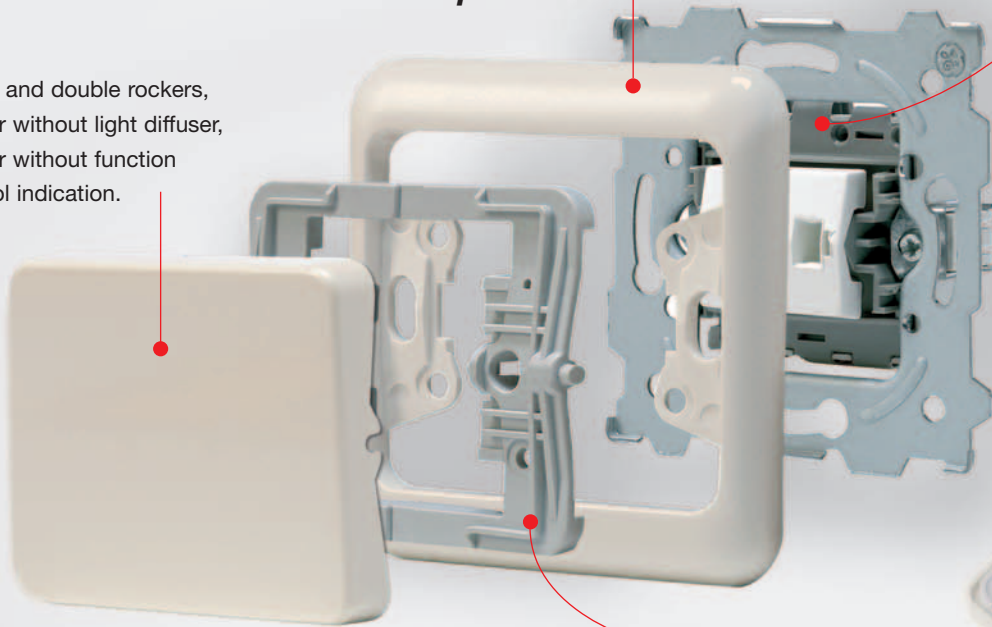

Lever on switch and lever interface on rocker

Intermediate piece.

Easy but tight mounting of the frame to the mechanism
Providing each rocker with a double pivot support
Allows for correct operation of the switch despite of mounting (angle) mismatch between mechanisms and frames/rockers

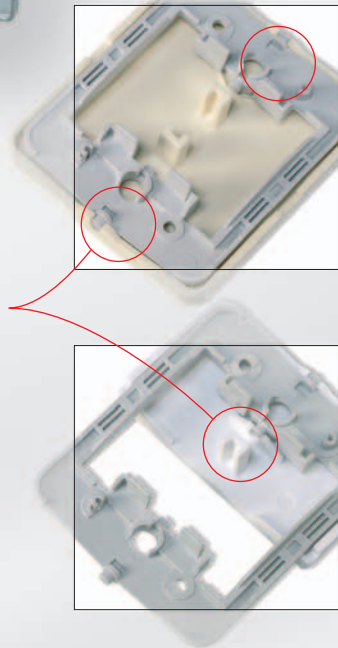

Easy mounting of lamp accessory

Mounting/contact holes for pilot or control lamp

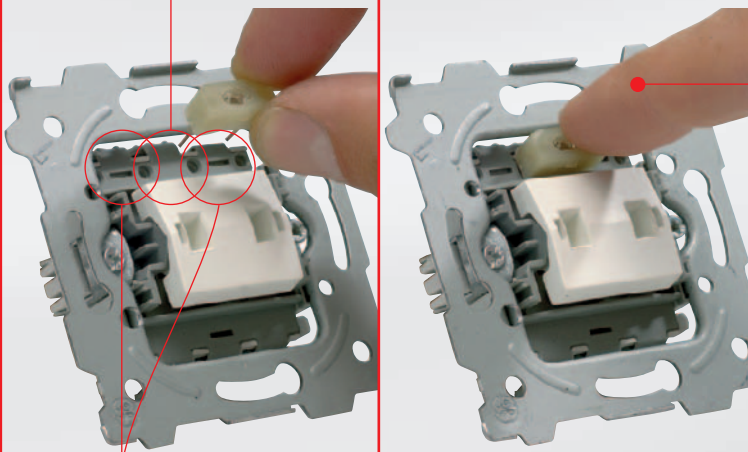

Easy installation: just by pushing in
No tools required

Same lamp and same mounting principle for single and double switches

Easy replacing just by pulling out

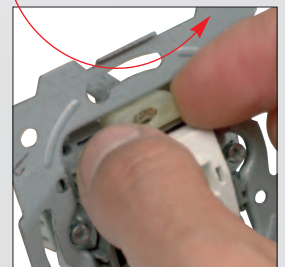

Thermoplastic socket-outlet

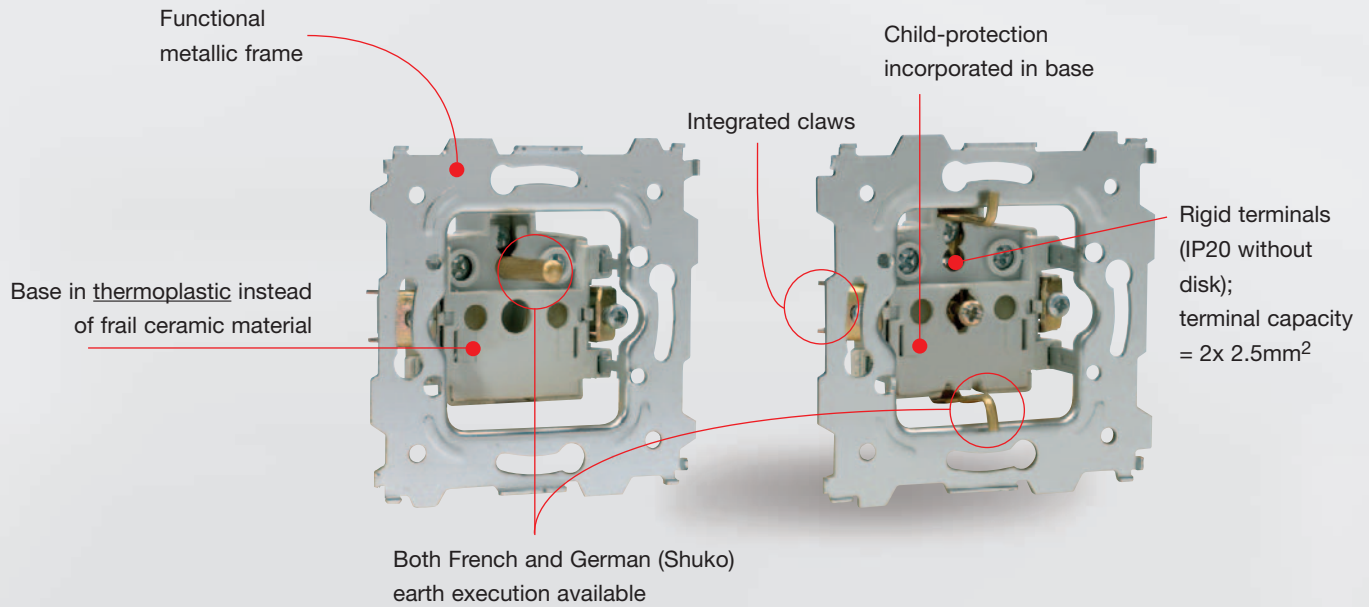

Standards

In compliance with

IEC 60669-1

EN 60669-1

NBN EN 60669-1

Approvals



Notes

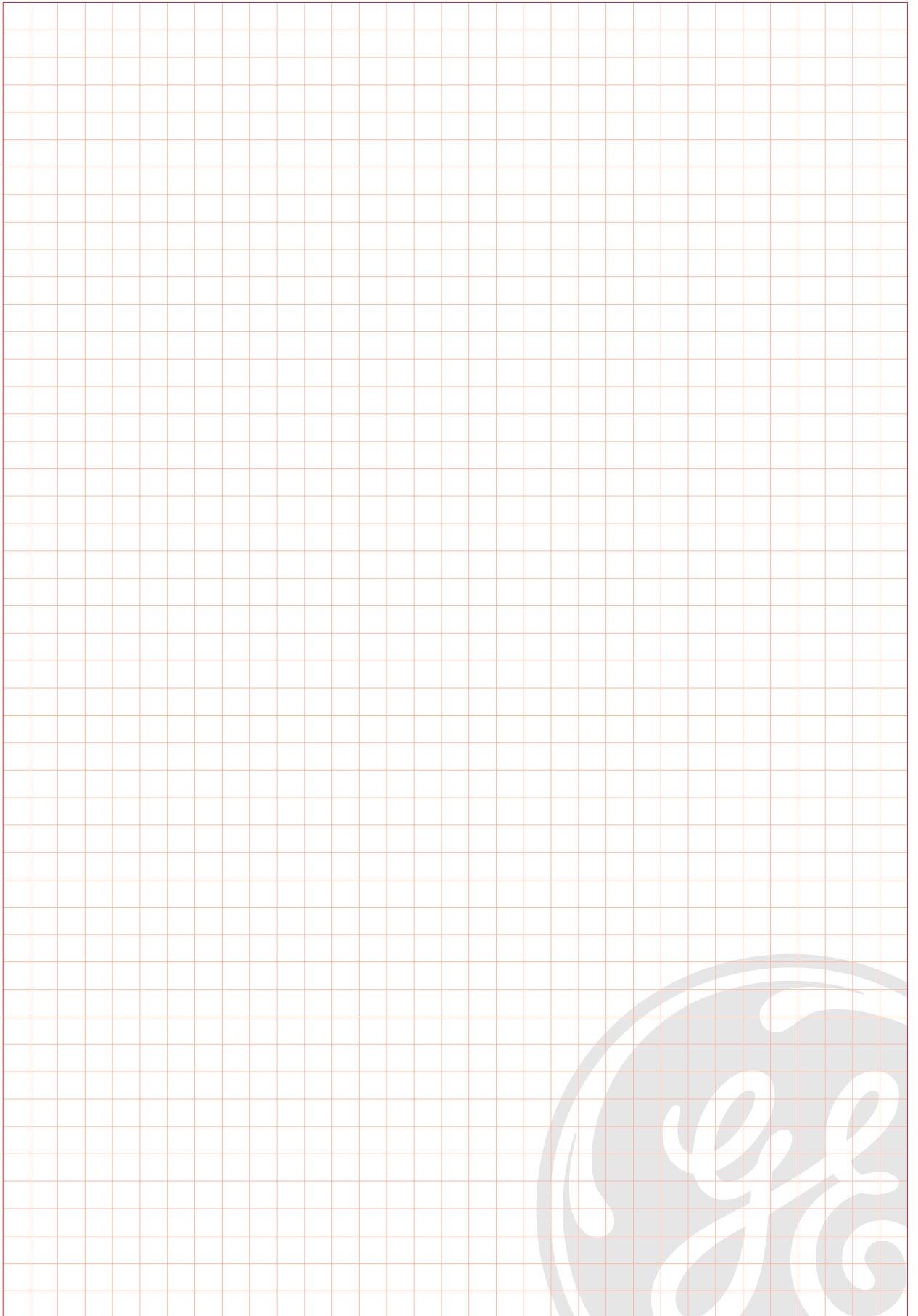



Presentation

SintraPlus stands for a series of mechanisms providing the thousand and one solutions that design, ambiance, decoration and good taste demand nowadays. High quality finishing, combined with the use of specific raw materials for these products, maintain the shine and original appearance of their first day. The colours have been designed for use in any environment: teenager, modern, informal, distinguished, classic, etc. The wide range of colours offers the possibility of combining them according the personal taste.

Basic range

Mechanisms with fast connection

- Flush mounting.
- To build into walls by clamps or screws.
- For standard Ø60mm boxes.
- The external parts of the complete range are made of heat stable resin.
- Switch mechanism with heat stable resin and polycarbonate parts with 10% self-extinguishing glass fibre.
- According to EN 60669 standard.
- 10A - 250V switches.
- Switches with fast connection for rigid and flexible wires.
- Switches with and without indicator lamp (with neon lamp incorporated).
- Switches with and without symbol markings.
- Silver alloy switch contacts.
- Compliance with standards, see page A.32.

Composition

Basic range. White and ivory



Mechanism with rocker or cover

+



Frame

=



Complete set



With claws

Switches



| | Model | Mechanism | | | Pack. |
|-------------------------------|-----------|-----------|------------|--------|-------|
| | | Basic | With cover | | |
| | | | White | Ivory | |
| Single pole | 337 / F | 582065 | 584751 | 584682 | 10 |
| Double pole. With I-O symbols | 337 / 3 F | 582070 | 584755 | 584688 | 10 |
| Changeover | 337 / 2 F | 582076 | 584765 | 584700 | 10 |
| Intermediate | 337 / 4 F | 582085 | 584758 | 584692 | 10 |

Switches with pilot lamp



| | | | | | |
|--------------|------------|--------|--------|--------|----|
| Single pole | 337 / LF | 582066 | 584752 | 584684 | 10 |
| Changeover | 337 / 2 LF | 582078 | 584767 | 584702 | 10 |
| Intermediate | 337 / 4 LF | 582086 | 584759 | 584693 | 10 |

Switches with control lamp



| | | | | | |
|-------------------------------|------------|--------|--------|--------|----|
| Single pole | 337 / SF | 582067 | 584753 | 584685 | 10 |
| Changeover | 337 / 2 SF | 582079 | 584762 | 584695 | 10 |
| Double pole. With I-O symbols | 337 / 3 SF | 582071 | 584754 | 584683 | 10 |

Double mechanisms

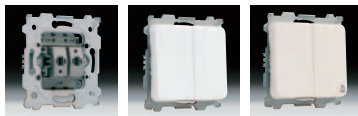

| | | | | | |
|--|-------------|--------|--------|--------|----|
| 2 x single pole | 337 / 1 F | 582073 | 584769 | 584699 | 10 |
| 2 x changeover | 337 / 2 DF | 582077 | 584766 | 584701 | 10 |
| Changeover + push-button. With bell symbol | 337 / 26 CF | 582080 | 584768 | 584697 | 10 |
| Changeover + push-button. With lamp symbol | 337 / 26 GF | 582080 | 584772 | 584703 | 10 |
| Changeover + push-button. With key symbol | 337 / 26 TF | 582080 | 584773 | 584704 | 10 |

Push-buttons

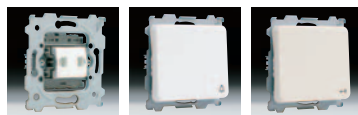

| | | | | | |
|------------------------------|------------|--------|--------|--------|----|
| Single pole without symbol | 337 / 6 NF | 582092 | 584781 | 584711 | 10 |
| Single pole with bell symbol | 337 / 6 CF | 582092 | 584780 | 584710 | 10 |
| Single pole with lamp symbol | 337 / 6 GF | 582092 | 584782 | 584712 | 10 |
| Single pole with key symbol | 337 / 6 TF | 582092 | 584783 | 584713 | 10 |

Push-buttons with pilot lamp



| | | | | | |
|------------------------------|-------------|--------|--------|--------|----|
| Single pole without symbol | 337 / 6 LNF | 582093 | 584784 | 584715 | 10 |
| Single pole with bell symbol | 337 / 6 LCF | 582093 | 584785 | 584716 | 10 |
| Single pole with lamp symbol | 337 / 6 LGF | 582093 | 584786 | 584717 | 10 |
| Single pole with key symbol | 337 / 6 LTF | 582093 | 584787 | 584718 | 10 |

Switch for shutters & fans



| | | | | | |
|----------------------------------|------------|--------|--------|--------|----|
| Push-button | 337 / 6 DF | 582095 | 584788 | 584714 | 10 |
| Switch with mechanical interlock | 337 / 1 DF | 582074 | 584764 | 584687 | 10 |

Double mechanisms with pilot lamp



| | | | | | |
|-----------------|-------------|--------|--------|--------|----|
| 2 x single pole | 337 / 1 LF | 582072 | 584770 | 584698 | 10 |
| 2 x changeover | 337 / 2 DLF | 582075 | 584763 | 584700 | 10 |

A

With claws
Ceramic socket



Socket-outlets (double pole)

| | Model | Mechanism | | | Pack. |
|--|-------------|-----------|---------------|--------|-------|
| | | Basic | With cover | | |
| | | | Without cover | White | |
| Without earth | 237 / 5 | 585151 | 586230 | 586030 | 10 |
| Without earth + child protection | C 237 / 5 | 585153 | 586232 | 586032 | 10 |
| Earth (standard Switzerland/Spain) | T 237 / 5 | 585156 | 586236 | 586036 | 10 |
| Earth Schuko (standard Germany) | K 237 / 5 | 585154 | 586234 | 586034 | 10 |
| Earth Schuko + child protect. (standard Germany) | KC 237 / 5 | 585152 | 586238 | 586038 | 10 |
| Earth Schuko + cover (standard Germany) | KT 237 / 5 | 585155 | 586239 | 586039 | 10 |
| Earth Schuko + transp. cover (standard Germany) | KT 237 / 5 | 585155 | 586237 | 586037 | 10 |
| Earth France + child protection | TEC 237 / 5 | 585158 | 586242 | 586042 | 10 |
| Standard Israel | 237 / 5 IF | - | 587514 | - | 10 |

- Flush mounting.
- To build into walls by claws or screws.
- For standard Ø60mm boxes.
- The external parts of the complete range are made of heat stable resin.

- Socket-outlets according to CEI 884 and CEE 7.
- 10-16A / 250V socket-outlets.
- Socket-outlets with and without child protection.
- Socket-outlets with porcelain inside. High heat resistance.
- Compliance with standards, see page A.32.

Thermoplastic socket



Socket-outlets (double pole)

| | | | | | |
|---|-------------|--------|--------|--------|----|
| Without earth | 337 / 5 | 585228 | 588921 | 588851 | 10 |
| Without earth + child protection* | C 337 / 5 | 585230 | 588923 | 588853 | 10 |
| Earth France + child protection* | TEC 337 / 5 | 585232 | 588925 | 588855 | 10 |
| Earth Schuko (standard Germany) | K 337 / 5 | 585229 | 588922 | 588852 | 10 |
| Earth Schuko + child protection (standard Germany)* | KC 337 / 5 | 585231 | 588924 | 588854 | 10 |

* Under development

With claws

TV / FM socket-outlets



| | Model | Mechanism | | | Pack. |
|--|-------------|---------------|--------|------------|-------|
| | | Without cover | | With cover | |
| | | Basic | White | Ivory | |
| Individual TV/FM Ø 9.5 | TN 237 / 40 | 585135 | 586295 | 586095 | 10 |
| Terminal TV/FM Ø 9.5 | TN 237 / 41 | 585136 | 586296 | 586096 | 10 |
| 2 to 4 TV/FM Ø 9.5 in series connection | TN 237 / 42 | 585137 | 586297 | 586097 | 10 |
| 5 to 15 TV/FM Ø 9.5 in series connection | TN 237 / 43 | 585138 | 586298 | 586098 | 10 |
| Individual TV Ø 9.4 | TN 237 / 5F | 585162 | 586241 | 586041 | 10 |
| Individual TV/SAT Ø 9.5 | TS 337 / 40 | 510715 | - | - | 10 |
| Terminal TV/SAT Ø 9.5 | TS 337 / 41 | 510714 | - | - | 10 |
| 2 to 4 TV/SAT Ø 9.5 in series | TS 337 / 42 | 510713 | - | - | 10 |
| 5 to 10 TV/SAT Ø 9.5 in series | TS 337 / 43 | 510712 | - | - | 10 |

- Flush mounting.
- To build into walls by claws or screws.
- For standard Ø60mm boxes.
- The external parts of the complete range are made of heat stable resin.
- According to UNE 20-523-79 Part II, DIN 45330 and DIN 45325.

Telephone and informatic sockets



| | | | | | |
|--------------------------|---------------|--------|--------|--------|----|
| Standard France | TF 237 / 5F | 585161 | 586253 | 586053 | 10 |
| Standard Greece | TF 237 / 5 | 585160 | 586252 | 586052 | 10 |
| RITA (standard Portugal) | TF 237 / 5P | 585140 | 586250 | 286050 | 10 |
| 1 x RJ11 | TF 237 / 5E | 585288 | 586744 | 586544 | 10 |
| 1 x RJ12 | TF 237 / 5ES | 585289 | 586746 | 586546 | 10 |
| RJ45 | INF 237 / 5 | 585164 | 586255 | 586055 | 10 |
| 2 x RJ45 | INF 237 / 5D | 585286 | 585748 | 585548 | 10 |
| 2 x RJ11 | TF 237 / 5D | 585300 | 585750 | 585550 | 10 |
| RJ11 + RJ45 | T INF 237 / 5 | 585301 | 585751 | 585551 | 10 |

- To build into walls by screws
- For standard Ø60mm boxes.
- The external parts of the complete range are made of heat stable resin.
- Standards, see page A.32.

Dimmers

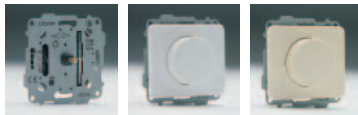

| | | | | | |
|---|----------|--------|--------|--------|---|
| Pulse changeover On/Off 230V 40-500W (Incandescent lamps, halogen conventional transformers) | 237 / 56 | 585173 | 586303 | 586103 | 1 |
| Pulse changeover On/Off 230V 10-300W (Incandescent lamps, halogen low voltage, electronic transformers) ⁽¹⁾ | 237 / 53 | 585176 | 586307 | 586107 | 1 |
| Pulse changeover On/Off 230V 40-500W (Incandescent lamps, halogen conventional transformers) ⁽¹⁾ | 237 / 56 | 585296 | 585803 | 585603 | 1 |
| Pulse changeover On/Off 230V 40-500W (Incandescent lamps, halogen conventional transformers) ⁽¹⁾ | 237 / 57 | 585177 | 586308 | 586108 | 1 |
| Sensitive pulse switch 230V 40-400W (Incandescent lamps, halogens, conventional transformers) ⁽¹⁾ | 237 / 58 | 585178 | 586309 | 586109 | 1 |

- Flush mounting.
- To build into walls by screws or claws.
- For standard Ø60mm boxes.
- The external parts of the complete range are made of heat stable resin.
- According to EN 60 669 standard.
- Compliance with standards, see page A.32.

(1) Without claws.

Cable exit



| | Model | Mechanism | | | Pack. |
|---|---------|---------------|------------|--------|-------|
| | | Without cover | With cover | | |
| | | Basic | White | Ivory | |
| Connection box, 3 tags | 237 / 8 | 585166 | 586291 | 586091 | 1 |
| <ul style="list-style-type: none"> - Flush mounting. - To build into walls by screws. - For standard Ø60mm boxes. <ul style="list-style-type: none"> - The external parts of the complete range are made of heat stable resin. - According to EN 60 669 standard. - Compliance with standards, see page A.32. | | | | | |

Card switch



| | Model | Basic | White | Ivory | Pack. |
|---|-------------|--------|--------|--------|-------|
| Card switch | 237 / 61 LF | 585107 | 586508 | 586608 | 1 |
| <ul style="list-style-type: none"> - Flush mounting. - To build into walls by screws. - For standard Ø60mm boxes. <ul style="list-style-type: none"> - The external parts of the complete range are made of heat stable resin. - According to EN 60 669 standard. - Compliance with standards, see page A.32. | | | | | |

Special switch⁽¹⁾



| | Model | Basic | White | Ivory | Pack. |
|-------------------------------------|--------------|--------|--------|--------|-------|
| Special switch for washing machines | LOR 237 / 71 | 585169 | 586305 | 586105 | 1 |

(1) To build in by claws or screws.

Cord switch



| | Model | Basic | White | Ivory | Pack. |
|--|------------|--------|--------|--------|-------|
| Single pole switch | CD 237 | 585104 | 586201 | 586001 | 10 |
| Single pole push-button | CD 237 / 6 | 585126 | 586274 | 586074 | 10 |
| <ul style="list-style-type: none"> - Flush mounting. - To build into walls by screws. - For standard Ø60mm boxes. - The external parts of the complete range are made of heat stable resin. - According to EN 60 669 standard. - Compliance with standards, see page A.32. | | | | | |

Buzzer



| | Model | Basic | White | Ivory | Pack. |
|--|----------|--------|--------|--------|-------|
| Buzzer (230V) | 237 / 35 | 585130 | 586286 | 586086 | 10 |
| <ul style="list-style-type: none"> - Warning buzzer with adjustable continuous sound. - Serie for built-in wall mounting by screws. - For standard Ø60mm boxes. - The external parts of complete range are made of heat stable resin. - Compliance with standards, see page A.32. | | | | | |

Socket for loudspeakers



| | Model | Basic | White | Ivory | Pack. |
|---|-----------|--------|--------|--------|-------|
| Socket for loudspeakers | 237 / 5 S | 585290 | 585743 | 585543 | 10 |
| <ul style="list-style-type: none"> - Series for built-in wall mounting by screws. - For standard Ø60mm boxes. - The external parts of complete range are made of heat stable resin. - According to DIN 41529 standard. - Compliance with standards, see page A.32. | | | | | |

Loudspeaker potentiometer

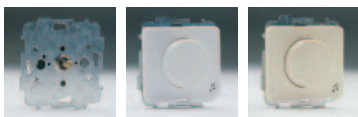

| | Model | Basic | White | Ivory | Pack. |
|--------------------------------------|----------|--------|--------|--------|-------|
| 5W (47 Ω) | 237 / 60 | 585297 | 585804 | 585604 | 1 |
| 5W + 5W stereo (47 Ω) ⁽²⁾ | 237 / 65 | 585299 | 585806 | 585606 | 1 |

(2) For boxes with depth 63 mm.



Notes

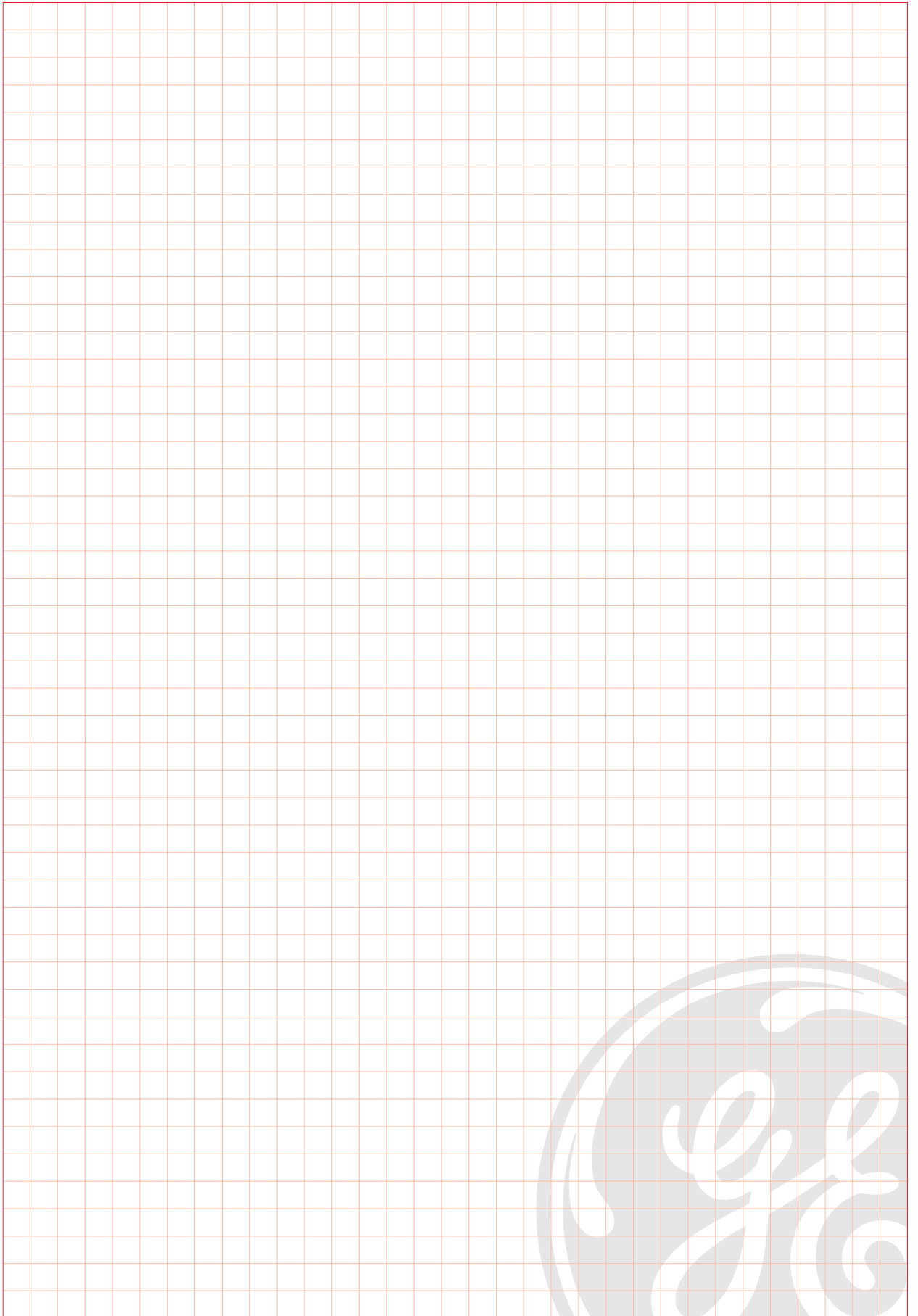

Coloured range

Mechanisms with fast connection

- For standard Ø60mm boxes.
- The external parts of the complete range are made of heat stable resin
- According to EN 60 669.
- Rockers with and without symbols.
- Single and double rockers with and without lamp.
- Compliance with standards, see page A.32.



Colours

| | |
|--|------------|
| | White |
| | Ivory |
| | Light grey |
| | Perle |
| | Yellow |
| | Green |
| | Red |
| | Bordeaux |
| | Terracotta |
| | Blue |
| | Brown |
| | Dark grey |
| | Black |
| | Dull brown |
| | Dull black |

Composition of the range

Page A.8-A.9

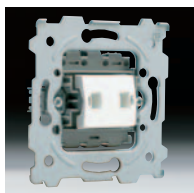

Mechanism

+



Rocker or cover

+



Frame

=



Complete set



Frames

Dimensions (mm)

| | |
|------------|-------------------|
| 1 element | 85x85 |
| 2 elements | Horizontal 157x85 |
| | Vertical 85x157 |
| 3 elements | Horizontal 229x85 |
| | Vertical 85x229 |

Distance between centres 72mm

Quick snap-on fixation.

Frames

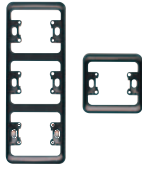
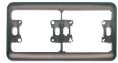

- 1 element
- 2 horizontal elements
- 2 vertical elements
- 3 horizontal elements
- 3 vertical elements

| | Standard colours | | | Pack. | Other colours | | Pack. |
|--------------|------------------|-------------|------------------|-------|------------------|------------------|-------|
| | White 03 | Ivory 06 | Light grey 05 | | Dull brown 12 | Dull black 11 | |
| S 237 / ... | 586310 | 586110 | 586420 | 20 | 588295 | 588345 | 10 |
| DH 237 / ... | 586312 | 586112 | 586421 | 10 | 588296 | 588346 | 10 |
| DV 237 / ... | 586315 | 586115 | 586422 | 10 | 588297 | 588347 | 10 |
| TH 237 / ... | 586318 | 586118 | 586423 | 10 | 588298 | 588348 | 10 |
| TV 237 / ... | 586321 | 586121 | 586424 | 10 | 588299 | 588349 | 10 |

Rockers



Switches
Single pole
Changeover
Intermediate

Push-button
Push-button without symbol

| | White 03 | Ivory 06 | Light grey 05 | Pack. | Dull brown 12 | Dull black 11 | Pack. |
|--|-------------|-------------|------------------|-------|------------------|------------------|-------|
| | 589915 | 589040 | 589080 | 10 | 589120 | 589160 | 10 |

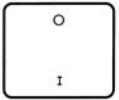

Switches
Double pole.
With I - O symbols

| | | | | | | | |
|--|--------|--------|--------|----|--------|--------|----|
| | 589919 | 589044 | 589084 | 10 | 589124 | 589164 | 10 |
|--|--------|--------|--------|----|--------|--------|----|

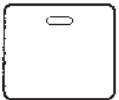

Switches with lamp
Single pole with control lamp
Single pole with pilot lamp
Changeover with control
Changeover with pilot lamp
Intermediate with pilot lamp

Push-button with lamp
Push-button without symbol

| | | | | | | | |
|--|--------|--------|--------|----|--------|--------|----|
| | 589925 | 589060 | 589100 | 10 | 589140 | 589180 | 10 |
|--|--------|--------|--------|----|--------|--------|----|



Switches with lamp
Double pole. With I - O symbols

| | | | | | | | |
|--|--------|--------|--------|----|--------|--------|----|
| | 589929 | 589064 | 589104 | 10 | 589144 | 589184 | 10 |
|--|--------|--------|--------|----|--------|--------|----|



Push-buttons
With symbol

| | | | | | | | |
|------|--------|--------|--------|----|--------|--------|----|
| Bell | 589916 | 589041 | 589081 | 10 | 589121 | 589161 | 10 |
| Lamp | 589917 | 589042 | 589082 | 10 | 589122 | 589162 | 10 |
| Key | 589918 | 589043 | 589083 | 10 | 589123 | 589163 | 10 |



Push-buttons with lamp
With symbol

| | | | | | | | |
|------|--------|--------|--------|----|--------|--------|----|
| Bell | 589926 | 589061 | 589101 | 10 | 589141 | 589181 | 10 |
| Lamp | 589927 | 589062 | 589102 | 10 | 589142 | 589182 | 10 |
| Key | 589928 | 589063 | 589103 | 10 | 589143 | 589183 | 10 |



Double mechanisms (pair)
2 x single pole
2 x changeover

| | | | | | | | |
|--|--------|--------|--------|----|--------|--------|----|
| | 589920 | 589050 | 589090 | 10 | 589130 | 589170 | 10 |
|--|--------|--------|--------|----|--------|--------|----|

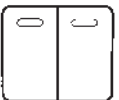

Double mechanisms (pair) with lamp
2 x single pole
2 x changeover

| | | | | | | | |
|--|--------|--------|--------|----|--------|--------|----|
| | 589895 | 589055 | 589095 | 10 | 589135 | 589175 | 10 |
|--|--------|--------|--------|----|--------|--------|----|

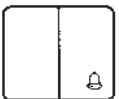

Double mechanisms
Changeover +
push-button (pair)

| | | | | | | | |
|------|--------|--------|--------|----|--------|--------|----|
| Bell | 589922 | 589052 | 589092 | 10 | 589132 | 589172 | 10 |
| Lamp | 589923 | 589053 | 589093 | 10 | 589133 | 589173 | 10 |
| Key | 589924 | 589054 | 589094 | 10 | 589134 | 589174 | 10 |

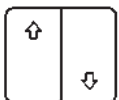

Switch for shutters & fans (pairs)
Push-button
Switch

| | | | | | | | |
|--|--------|--------|--------|----|--------|--------|----|
| | 589921 | 589051 | 589091 | 10 | 589131 | 589171 | 10 |
|--|--------|--------|--------|----|--------|--------|----|

| Other colours | | | | | | | | | | Pack. |
|---------------|-----------|----------|--------|-------------|---------------|---------|----------|--------------|----------|-------|
| Perle 16 | Yellow 01 | Green 08 | Red 09 | Bordeaux 19 | Terracotta 29 | Blue 17 | Brown 13 | Dark grey 15 | Black 10 | |
| | | | | | | | | | | |
| 586360 | 586330 | 586340 | 586350 | 586390 | 586380 | 586370 | 587750 | 586410 | 586430 | 10 |
| 586361 | 586331 | 586341 | 586351 | 586391 | 586381 | 586371 | 587751 | 586411 | 586431 | 10 |
| 586362 | 586332 | 586342 | 586352 | 586392 | 586382 | 586372 | 587752 | 586412 | 586432 | 10 |
| 586363 | 586333 | 586343 | 586353 | 586393 | 586383 | 586373 | 587753 | 586413 | 586433 | 10 |
| 586364 | 586334 | 586344 | 586354 | 586394 | 586384 | 586374 | 587754 | 586414 | 586434 | 10 |

| Perle 16 | Yellow 01 | Green 08 | Red 09 | Bordeaux 19 | Terracotta 29 | Blue 17 | Brown 13 | Dark grey 15 | Black 10 | Pack. |
|----------|-----------|----------|--------|-------------|---------------|---------|----------|--------------|----------|-------|
| | | | | | | | | | | |
| 589200 | 589240 | 589280 | 589320 | 589360 | 589400 | 589440 | 589480 | 589600 | 589640 | 10 |
| 589204 | 589244 | 589284 | 589324 | 589364 | 589404 | 589444 | 589484 | 589604 | 589644 | 10 |
| 589220 | - | 589300 | 589340 | 589380 | 589420 | - | 589500 | 589620 | 589660 | 10 |
| 589224 | 589264 | 589304 | 589344 | 589384 | 589424 | 589464 | 589504 | 589624 | 589664 | 10 |
| 589201 | 589241 | 589281 | 589321 | 589361 | 589401 | 589441 | 589481 | 589601 | 589641 | 10 |
| 589202 | 589242 | 589282 | 589322 | 589362 | 589402 | 589442 | 589482 | 589602 | 589642 | 10 |
| 589203 | 589243 | 589283 | 589323 | 589363 | 589403 | 589443 | 589483 | 589603 | 589643 | 10 |
| 589221 | 589261 | 589301 | 589341 | 589381 | 589421 | 589461 | 589501 | 589621 | 589661 | 10 |
| 589222 | 589262 | 589302 | 589342 | 589382 | 589422 | 589462 | 589502 | 589622 | 589662 | 10 |
| 589223 | 589263 | 589303 | 589343 | 589383 | 589423 | 589463 | 589503 | 589623 | 589663 | 10 |
| 589210 | 589250 | 589290 | 589330 | 589370 | 589410 | 589450 | 589490 | 589610 | 589650 | 10 |
| 589215 | 589255 | 589295 | 589335 | 589375 | 589415 | 589455 | 589495 | 589615 | 589655 | 10 |
| 589212 | 589252 | 589292 | 589332 | 589372 | 589412 | 589452 | 589492 | 589612 | 589652 | 10 |
| 589213 | 589253 | 589293 | 589333 | 589373 | 589413 | 589453 | 589493 | 589613 | 589653 | 10 |
| 589214 | 589254 | 589294 | 589334 | 589374 | 589414 | 589454 | 589494 | 589614 | 589654 | 10 |
| 589211 | 589251 | 589291 | 589331 | 589371 | 589411 | 589451 | 589491 | 589611 | 589651 | 10 |



Covers

Ceramic socket



Socket-outlet
Double pole without earth

| Standard colours | | | Pack. | Other colours | | Pack. |
|------------------|----------|---------------|-------|---------------|---------------|-------|
| White 03 | Ivory 06 | Light grey 05 | | Dull brown 12 | Dull black 11 | |
| | | | | | | |
| 586990 | 586940 | 587090 | 10 | 588264 | 588314 | 10 |



Socket-outlet
Double pole without earth + child protection

| | | | | | | |
|--------|--------|--------|----|--------|--------|----|
| 586989 | 586939 | 587089 | 10 | 588265 | 588315 | 10 |
|--------|--------|--------|----|--------|--------|----|



Socket-outlet
Double pole + earth
(standard Switzerland/Spain)

| | | | | | | |
|--------|--------|--------|----|--------|--------|----|
| 586987 | 586937 | 587087 | 10 | 588272 | 588322 | 10 |
|--------|--------|--------|----|--------|--------|----|



Socket-outlet
Double pole + earth Schuko
(standard Germany)

| | | | | | | |
|--------|--------|--------|----|--------|--------|----|
| 586986 | 586936 | 587086 | 10 | 588266 | 588316 | 10 |
|--------|--------|--------|----|--------|--------|----|



Socket-outlet
Double pole + earth Schuko + child protection
(std. Germany)

| | | | | | | |
|--------|--------|--------|----|--------|--------|--|
| 586985 | 586935 | 587085 | 10 | 588267 | 588317 | |
|--------|--------|--------|----|--------|--------|--|



Socket-outlet (pair)
Double pole + earth Schuko
(standard Germany)

| | | | | | | | |
|--------------------------|--------|--------|--------|----|--------|--------|----|
| Standard cover | 586992 | 586942 | 587092 | 10 | 588268 | 588318 | 10 |
| Transparent cover | 586993 | 586943 | 587093 | 10 | - | - | 10 |



Socket-outlet
Double pole + earth + child protection
(standard France)

| | | | | | | |
|--------|--------|--------|----|--------|--------|----|
| 586988 | 586938 | 587088 | 10 | 588271 | 588321 | 10 |
|--------|--------|--------|----|--------|--------|----|

Thermoplastic socket



Socket-outlet
Double pole without earth
With and without child protection

| | | | | | | |
|--------|--------|--------|----|--------|--------|----|
| 589910 | 589065 | 589110 | 10 | 589150 | 589190 | 10 |
|--------|--------|--------|----|--------|--------|----|



Socket-outlet
Double pole + earth Schuko
With and without child protection

| | | | | | | |
|--------|--------|--------|----|--------|--------|----|
| 589912 | 589071 | 589112 | 10 | 589152 | 589192 | 10 |
|--------|--------|--------|----|--------|--------|----|



Socket-outlet
Double pole without earth + child protection
(standard France)

| | | | | | | |
|--------|--------|--------|----|--------|--------|----|
| 589911 | 589070 | 589111 | 10 | 589151 | 589191 | 10 |
|--------|--------|--------|----|--------|--------|----|



Telephone socket-outlet
RJ11 for 4 connections - RJ12 with 6 connections

| | | | | | | |
|--------|--------|--------|----|--------|--------|----|
| 586952 | 586902 | 587052 | 10 | 588274 | 588324 | 10 |
|--------|--------|--------|----|--------|--------|----|



Telephone socket-outlets
Standard France

| | | | | | | |
|--------|--------|--------|----|--------|--------|----|
| 586991 | 586941 | 587091 | 10 | 588273 | 588323 | 10 |
|--------|--------|--------|----|--------|--------|----|



Telephone socket-outlets
Standard Greece

| | | | | | | |
|--------|--------|--------|----|--------|--------|----|
| 586963 | 586913 | 587063 | 10 | 588275 | 588325 | 10 |
|--------|--------|--------|----|--------|--------|----|



Telephone socket-outlets
1 x RJ45 (Informatic)
2 x RJ45

| | | | | | | |
|--------|--------|--------|----|--------|--------|----|
| 586996 | 586946 | 587096 | 10 | 588276 | 588326 | 10 |
| 586955 | 586905 | 587055 | 10 | 588370 | 588375 | 10 |













Cable exit
Connection box. 3 tags

| | | | | | | |
|--------|--------|--------|----|--------|--------|----|
| 586953 | 586903 | 587053 | 10 | 588279 | 588329 | 10 |
|--------|--------|--------|----|--------|--------|----|















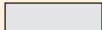

Blind cover











| | | | | | | |
|--------|--------|--------|----|--------|--------|----|
| 586995 | 586945 | 587095 | 10 | 588280 | 588330 | 10 |
|--------|--------|--------|----|--------|--------|----|

| Other colours | | | | | | | | | | Pack. |
|--|---|---|---|---|---|---|---|---|---|-------|
| Perle 16 | Yellow 01 | Green 08 | Red 09 | Bordeaux 19 | Terracotta 29 | Blue 17 | Brown 13 | Dark grey 15 | Black 10 | |
|  |  |  |  |  |  |  |  |  |  | |
| 587457 | 587660 | 587424 | 587692 | 587140 | 587489 | 587240 | 587740 | 587190 | 587289 | 10 |
| 587456 | 587659 | 587423 | 587691 | 587139 | 587488 | 587239 | 587739 | 587189 | 587290 | 10 |
| 587454 | 587657 | 587421 | 587689 | 587137 | 587486 | 587237 | 587737 | 587187 | 587287 | 10 |
| 587453 | 587656 | 587420 | 587688 | 587136 | 587485 | 587236 | 587736 | 587186 | 587286 | 10 |
| 587452 | 587655 | 587419 | 587687 | 587135 | 587484 | 587235 | 587735 | 587185 | 587285 | 10 |
| - | - | - | - | - | - | - | - | - | - | 10 |
| 587459 | 587662 | 587425 | 587693 | 587142 | 587491 | 587242 | 587743 | 587192 | 587292 | 10 |
| 587455 | 587658 | 587422 | 587690 | 587138 | 587487 | 587238 | 587738 | 587188 | 587288 | 10 |
| 589230 | 589270 | 589310 | 589350 | 589390 | 589430 | 589470 | 589510 | 589630 | 589670 | 10 |
| 589232 | 589272 | 589312 | 589352 | 589392 | 589432 | 589472 | 589512 | 589632 | 589672 | 10 |
| 589231 | 589271 | 589311 | 589351 | 589391 | 589431 | 589471 | 589511 | 589631 | 589671 | 10 |
| 587431 | 587634 | 587698 | 587666 | 587102 | 587463 | 587202 | 587746 | 587152 | 587252 | 10 |
| 587615 | 587619 | 587613 | 587617 | 587141 | 587611 | 587241 | 587741 | 587191 | 587291 | 10 |
| 587438 | 587641 | 587705 | 587673 | 587113 | 587470 | 587213 | 587702 | 587163 | 587263 | 10 |
| 587461 | 587664 | 587429 | 587696 | 587146 | 587493 | 587246 | 587701 | 587196 | 587296 | 10 |
| 588380 | 587632 | 587611 | 587780 | 587105 | 587497 | 587205 | 587707 | 587155 | 587255 | 10 |
| 587432 | 587635 | 587699 | 587667 | 587103 | 587464 | 587203 | 587703 | 587153 | 587253 | 10 |
| 587460 | 587663 | 587427 | 587695 | 587145 | 587492 | 587245 | 587745 | 587195 | 587295 | 10 |



Covers

| | Standard colours | | | Pack. | Other colours | | Pack. |
|---|---|---|--|-------|---|---|-------|
| | White 03 | Ivory 06 | Light grey 05 | | Dull brown 12 | Dull black 11 | |
|  <p>Special switch (pair) Switch for washing machines</p> |  |  |  | 1 |  |  | 1 |
| | 586954 | 586904 | 587054 | | 588283 | 588333 | |
|  <p>TV socket-outlet Only TV Ø 9.5 (Male)</p> | 586994 | 586944 | 587094 | 10 | 588277 | 588327 | 10 |
|  <p>TV socket-outlet Individual TV/FM Ø 9.5 Terminal TV/FM Ø 9.5 2 to 4 in series connection Ø 9.5 5 to 15 in series connection Ø 9.5</p> | 586958 | 586908 | 587058 | 10 | 588278 | 588328 | 10 |
|  <p>TV socket-outlet Individual TV/SAT Ø 9.5 Terminal TV/SAT Ø 9.5 2 to 4 in series connection Ø 9.5 5 to 15 in series connection Ø 9.5</p> | 589931 | 589932 | 589933 | 10 | 589934 | 589935 | 10 |
|  <p>Dimmer Pulse changeover (pair) With and without clamps</p> | 586950 | 586900 | 587050 | 1 | 588281 | 588331 | 1 |
|  <p>Dimmer Sensitive pulse switch (pair)</p> | 586951 | 586901 | 587051 | 1 | 588287 | 588337 | 1 |
|  <p>Cord switch Single pole (pair) Push-button (pair)</p> | 586956 | 586906 | 587056 | 10 | 588282 | 588332 | 10 |
|  <p>Buzzer</p> | 586964 | 586914 | 587064 | 10 | 588284 | 588334 | 10 |
|  <p>Card switch</p> | 586983 | 586933 | 587083 | 1 | - | - | - |
|  <p>Socket for loudspeakers</p> | 586957 | 586907 | 587057 | 10 | 588286 | 588336 | 10 |
|  <p>Potentiometer for loudspeakers 5W and 5W + 5W stereo (pair)</p> | 586962 | 586912 | 587062 | 1 | 588285 | 588335 | 1 |

| Other colours | | | | | | | | | | Pack. |
|--|---|---|---|---|---|---|---|--|---|-------|
| Perle 16 | Yellow 01 | Green 08 | Red 09 | Bordeaux 19 | Terracotta 29 | Blue 17 | Brown 13 | Dark grey 15 | Black 10 | |
|  |  |  |  |  |  |  |  |  |  | |
| 587668 | 587636 | 587400 | 587668 | 587104 | 587465 | 587204 | 587704 | 587154 | 587254 | 1 |
| 587614 | 587618 | 587612 | 587616 | 587144 | 587610 | 587244 | 587744 | 587194 | 587294 | 10 |
| 587436 | 587639 | 587403 | 587671 | 587108 | 587468 | 587208 | 587708 | 587158 | 587258 | 10 |
| 589936 | 589937 | 589938 | 589939 | 589940 | 589941 | 589942 | 589943 | 589944 | 589945 | 10 |
| 587430 ⁽¹⁾ | 587640 ⁽¹⁾ | 587600 ⁽¹⁾ | 587665 ⁽¹⁾ | 587100 ⁽¹⁾ | 587462 ⁽¹⁾ | 587200 ⁽¹⁾ | 587700 ⁽¹⁾ | 587150 ⁽¹⁾ | 587250 ⁽¹⁾ | 1 |
| 587631 ⁽¹⁾ | 587628 ⁽¹⁾ | 587604 ⁽¹⁾ | 587697 ⁽¹⁾ | 587101 ⁽¹⁾ | 587496 ⁽¹⁾ | 587201 ⁽¹⁾ | 587710 ⁽¹⁾ | 587151 ⁽¹⁾ | 587251 ⁽¹⁾ | 1 |
| 587434 | 587633 | 587402 | 587669 | 587106 | 587467 | 587206 | 587706 | 587156 | 587256 | 10 |
| 587435 | 587661 | 587428 | 587694 | 587114 | 587469 | 587214 | 587714 | 587164 | 587264 | 10 |
| - | - | - | - | - | - | - | - | - | - | - |
| 587603 | 587638 | 587602 | 587670 | 587107 | 587494 | 587207 | 587719 | 587157 | 587257 | 10 |
| 587630 ⁽¹⁾ | 587637 ⁽¹⁾ | 587605 ⁽¹⁾ | 587672 ⁽¹⁾ | 587112 ⁽¹⁾ | 587490 ⁽¹⁾ | 587212 ⁽¹⁾ | 587709 ⁽¹⁾ | 587162 ⁽¹⁾ | 587262 ⁽¹⁾ | 1 |

(1) Button in light grey colour.



Notes

A





Metallic range

Mechanisms with fast connection

- For standard Ø60mm boxes.
- The external parts of the complete range are made of heat stable resin
- According to EN 60 669.
- Rockers with and without symbols.
- Single and double rockers with and without lamp.
- Compliance with standards, see page A.32.





Presentation

The SintraPlus Metallic range offers the identical characteristics as the series "Basic" and "Colours", but attains elegance, distinction, design and originality with the most advanced technology.

Suitable tones, which can be integrated into the most demanding environments.

The SintraPlus Metallic range provides solutions in everything and for everything.

Colours

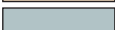
| | |
|---|----------|
|  | Bronze |
|  | Graphite |
|  | Moss |
|  | Old gold |
|  | Silver |

Composition of the range

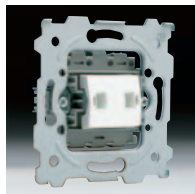

Mechanism With claws

+



Rocker or cover

+



Frame

=







Complete set







Rockers and covers

Switches

| | Bronze 18 | Graphite 14 | Moss 20 | Old gold 21 | Silver 22 | Pack. |
|-------------------------------|---|---|--|---|---|-------|
| |  |  |  |  |  | |
| Single pole | 589680 | 589720 | 589760 | 589800 | 589840 | 10 |
| Double pole. With I-O symbols | 589684 | 589724 | 589764 | 589804 | 589844 | 10 |
| Changeover | 589680 | 589720 | 589760 | 589800 | 589840 | 10 |
| Intermediate | 589680 | 589720 | 589760 | 589800 | 589840 | 10 |





For basic mechanisms, see page A.8

Switches with pilot/control lamp

| | Bronze 18 | Graphite 14 | Moss 20 | Old gold 21 | Silver 22 | Pack. |
|-------------------------------|---|---|--|---|---|-------|
| |  |  |  |  |  | |
| Single pole | 589700 | 589740 | 589780 | 589820 | 589860 | 10 |
| Double pole. With I-O symbols | 589704 | 589744 | 589784 | 589824 | 589864 | 10 |
| Changeover | 589700 | 589740 | 589780 | 589820 | 589860 | 10 |
| Intermediate | 589700 | 589740 | 589780 | 589820 | 589860 | 10 |





For basic mechanisms, see page A.8

Double mechanisms

| | Bronze 18 | Graphite 14 | Moss 20 | Old gold 21 | Silver 22 | Pack. |
|--|---|---|--|---|---|-------|
| |  |  |  |  |  | |
| 2 x single pole (pair) | 589690 | 589730 | 589770 | 589810 | 589850 | 10 |
| 2 x changeover (pair) | 589690 | 589730 | 589770 | 589810 | 589850 | 10 |
| Changeover + push-button (pair) with bell symbol | 589692 | 589732 | 589772 | 589812 | 589852 | 10 |
| Changeover + push-button (pair) with lamp symbol | 589693 | 589733 | 589773 | 589813 | 589853 | 10 |
| Changeover + push-button (pair) with key symbol | 589694 | 589734 | 589774 | 589814 | 589854 | 10 |





For basic mechanisms, see page A.8

Double mechanisms with pilot lamp

| | Bronze 18 | Graphite 14 | Moss 20 | Old gold 21 | Silver 22 | Pack. |
|------------------------|---|---|--|---|---|-------|
| |  |  |  |  |  | |
| 2 x single pole (pair) | 589695 | 589735 | 589775 | 589815 | 589855 | 10 |
| 2 x changeover (pair) | 589695 | 589735 | 589775 | 589815 | 589855 | 10 |





For basic mechanisms, see page A.8

Push-buttons

| | Bronze 18 | Graphite 14 | Moss 20 | Old gold 21 | Silver 22 | Pack. |
|------------------------------|---|---|--|---|---|-------|
| |  |  |  |  |  | |
| Single pole without symbol | 589680 | 589720 | 589760 | 589800 | 589840 | 10 |
| Single pole with bell symbol | 589681 | 589721 | 589761 | 589801 | 589841 | 10 |
| Single pole with lamp symbol | 589682 | 589722 | 589762 | 589802 | 589842 | 10 |
| Single pole with key symbol | 589683 | 589723 | 589763 | 589803 | 589843 | 10 |





For basic mechanisms, see page A.8

Push-buttons with pilot lamp

| | Bronze 18 | Graphite 14 | Moss 20 | Old gold 21 | Silver 22 | Pack. |
|------------------------------|---|---|---|--|---|-------|
| |  |  |  |  |  | |
| Single pole without symbol | 589700 | 589740 | 589780 | 589820 | 589860 | 10 |
| Single pole with bell symbol | 589701 | 589741 | 589781 | 589821 | 589861 | 10 |
| Single pole with lamp symbol | 589702 | 589742 | 589782 | 589822 | 589862 | 10 |
| Single pole with key symbol | 589703 | 589743 | 589783 | 589823 | 589863 | 10 |





For basic mechanisms, see page A.8

Switch for shutters & fans

| | Bronze 18 | Graphite 14 | Moss 20 | Old gold 21 | Silver 22 | Pack. |
|---|---|---|---|--|---|-------|
| |  |  |  |  |  | |
| Push-buttons (pair) | 589691 | 589731 | 589771 | 589811 | 589851 | 10 |
| Switch with mechanical interlock (pair) | 589691 | 589731 | 589771 | 589811 | 589851 | 10 |

For basic mechanisms, see page A.8

Socket-outlets (double pole)





| | Bronze 18 | Graphite 14 | Moss 20 | Old gold 21 | Silver 22 | Pack. |
|--|---|---|---|--|---|-------|
| Ceramic socket |  |  |  |  |  | |
| Without earth | 588014 | 588064 | 588114 | 588164 | 588214 | 10 |
| Without earth + child protection | 588015 | 588065 | 588115 | 588165 | 588215 | 10 |
| Earth (standard Switzerland/Spain) | 588022 | 588072 | 588122 | 588172 | 588222 | 10 |
| Earth Schuko (standard Germany) | 588016 | 588066 | 588116 | 588166 | 588216 | 10 |
| Earth Schuko + child protection (standard Germany) | 588017 | 588067 | 588117 | 588167 | 588217 | 10 |
| Earth Schuko + cover (standard Germany) (pair) | 588018 | 588068 | 588118 | 588168 | 588218 | 10 |
| Earth + child protection (standard France) | 588021 | 588071 | 588121 | 588171 | 588221 | 10 |

For basic mechanisms, see page A.9

Thermoplastic socket

| | | | | | | |
|------------------------|--------|--------|--------|--------|--------|----|
| Without earth | 589710 | 589750 | 589790 | 589830 | 589870 | 10 |
| Lateral earth (Schuko) | 589712 | 589752 | 589792 | 589832 | 589872 | 10 |
| French socket | 589711 | 589751 | 589791 | 589831 | 589871 | 10 |





Telephone socket-outlets

| | Bronze 18 | Graphite 14 | Moss 20 | Old gold 21 | Silver 22 | Pack. |
|-------------------------|---|---|---|--|---|-------|
| |  |  |  |  |  | |
| Standard Portugal | 588024 | 588074 | 588124 | 588174 | 588224 | 10 |
| RJ11 with 4 connections | 588024 | 588074 | 588124 | 588174 | 588224 | 10 |
| RJ12 with 6 connections | 588024 | 588074 | 588124 | 588174 | 588224 | 10 |
| RJ45 (informatic) | 588026 | 588076 | 588126 | 588176 | 588226 | 10 |
| Standard France | 588023 | 588073 | 588123 | 588173 | 588223 | 10 |
| Standard Greece | 588025 | 588075 | 588125 | 588175 | 588225 | 10 |

For basic mechanisms, see page A.10







TV / FM socket-outlets

| | Bronze 18 | Graphite 14 | Moss 20 | Old gold 21 | Silver 22 | Pack. |
|---|---|---|--|---|---|-------|
| |  |  |  |  |  | |
| Individual TV/FM Ø 9.4 | 588027 | 588077 | 588127 | 588177 | 588227 | 10 |
| Individual TV Ø 9.5 | 588028 | 588078 | 588128 | 588178 | 588228 | 10 |
| Terminal TV/FM Ø 9.5 | 588028 | 588078 | 588128 | 588178 | 588228 | 10 |
| 2 to 4 TV/FM Ø 9.5 in series connection | 588028 | 588078 | 588128 | 588178 | 588228 | 10 |
| 5 to 15 TV/FM Ø 9.5 in series connection | 588028 | 588078 | 588128 | 588178 | 588228 | 10 |
| Individual TV/SAT Ø 9.5 | 589946 | 589947 | 589948 | 589949 | 589950 | 10 |
| Terminal TV/SAT Ø 9.5 | 589946 | 589947 | 589948 | 589949 | 589950 | 10 |
| 2 to 4 TV/SAT Ø 9.5 in series connection | 589946 | 589947 | 589948 | 589949 | 589950 | 10 |
| 5 to 15 TV/SAT Ø 9.5 in series connection | 589946 | 589947 | 589948 | 589949 | 589950 | 10 |





For basic mechanisms, see page A.10

Cable exit

| | Bronze 18 | Graphite 14 | Moss 20 | Old gold 21 | Silver 22 | Pack. |
|------------------------|---|---|--|---|---|-------|
| |  |  |  |  |  | |
| Connection box. 3 tags | 588029 | 588079 | 588129 | 588179 | 588229 | 10 |
| Blind cover (pair) | 588030 | 588080 | 588130 | 588180 | 588230 | 10 |





For basic mechanisms, see page A.11

Dimmer

| | Bronze 18 | Graphite 14 | Moss 20 | Old gold 21 | Silver 22 | Pack. |
|---|---|---|--|---|---|-------|
| |  |  |  |  |  | |
| Pulse changeover On/Off 230V 10-300W (pair) | 588031 | 588081 | 588131 | 588181 | 588231 | 1 |
| Pulse changeover On/Off 230V 40-500W (pair) | 588031 | 588081 | 588131 | 588181 | 588231 | 1 |
| Sensitive pulse switch 230V 40-400W (pair) | 588037 | 588087 | 588137 | 588187 | 588237 | 1 |





For basic mechanisms, see page A.10

Cord switch





| | Bronze 18 | Graphite 14 | Moss 20 | Old gold 21 | Silver 22 | Pack. |
|--------------------------------|---|---|--|---|---|-------|
| |  |  |  |  |  | |
| Single pole switch (pair) | 588032 | 588082 | 588132 | 588182 | 588232 | 10 |
| Single pole push-button (pair) | 588032 | 588082 | 588132 | 588182 | 588232 | 10 |

For basic mechanisms, see page A.11





Special switch

| | Bronze 18 | Graphite 14 | Moss 20 | Old gold 21 | Silver 22 | Pack. |
|-----------------------------|---|---|--|---|---|-------|
| |  |  |  |  |  | |
| For washing machines (pair) | 588033 | 588083 | 588133 | 588183 | 588233 | 1 |





For basic mechanisms, see page A.11

| Buzzer | | | | | | |
|---------------|---|---|---|--|---|-------|
| | Bronze 18 | Graphite 14 | Moss 20 | Old gold 21 | Silver 22 | Pack. |
| |  |  |  |  |  | |
| Buzzer (220V) | 588034 | 588084 | 588134 | 588184 | 588234 | 10 |

For basic mechanisms, see page A.11

| Socket for loudspeakers | | | | | | |
|--------------------------------|---|---|---|--|---|-------|
| | Bronze 18 | Graphite 14 | Moss 20 | Old gold 21 | Silver 22 | Pack. |
| |  |  |  |  |  | |
| Socket for loudspeakers | 588036 | 588086 | 588136 | 588186 | 588236 | 10 |

For basic mechanisms, see page A.11

| Loudspeaker potentiometer | | | | | | |
|----------------------------------|--|--|--|---|--|-------|
| | Bronze 18 | Graphite 14 | Moss 20 | Old gold 21 | Silver 22 | Pack. |
| |  |  |  |  |  | |
| 5W (pair) | 588035 | 588085 | 588135 | 588185 | 588235 | 1 |
| 5W + 5W stereo (pair) | 588035 | 588085 | 588135 | 588185 | 588235 | 1 |

For basic mechanisms, see page A.11

| Frames | | | | | | |
|------------------------|--------------|----------------|------------|----------------|--------------|-------|
| | Bronze 18 | Graphite 14 | Moss 20 | Old gold 21 | Silver 22 | Pack. |
| 1 element | 588045 | 588095 | 588145 | 588195 | 588245 | 10 |
| 2 elements, horizontal | 588046 | 588096 | 588146 | 588196 | 588246 | 10 |
| 2 elements, vertical | 588047 | 588097 | 588147 | 588197 | 588247 | 10 |
| 3 elements, horizontal | 588048 | 588098 | 588148 | 588198 | 588248 | 10 |
| 3 elements, vertical | 588049 | 588099 | 588149 | 588199 | 588249 | 10 |

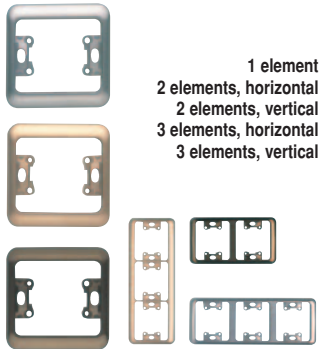

**For all outdoor applications
IP65 watertight and dustproof**

Easy wiring entry

Modern look

IP65 membrane

Easy installation

Ample space for wiring







Illuminated label holder

Flexible fixation

Perfect protection also for socket-outlet



Monoblock range

| | Description | Ref. No. | Pack. |
|---|--|-----------------|--------------|
|  | Single switch | 584100 | 10 |
| | 16A single switch | 584101 | 10 |
| | Changeover | 584102 | 10 |
| | 2 pole switch I-O | 584103 | 10 |
| | Intermediate | 584104 | 10 |
|  | Single switch with pilot lamp | 584105 | 10 |
| | Changeover with pilot lamp | 584106 | 10 |
| | Intermediate with pilot lamp | 584107 | 10 |
| | Single switch with control lamp | 584108 | 10 |
|  | Single switch with illuminated label holder (pilot) | 584109 | 10 |
| | Changeover with illuminated label holder (pilot) | 584110 | 10 |
| | Intermediate with illuminated label holder (pilot) | 584111 | 10 |
| | Single switch with illuminated label holder (control) | 584112 | 10 |
| | Remark: Pilot: lamp NOT operated by switch Control: lamp operated by switch | | |
|  | 2 x single switch | 584113 | 10 |
| | 2 x changeover | 584114 | 10 |
|  | Push-button without symbol | 584115 | 10 |
| | Push-button with bell symbol | 584116 | 10 |
| | Push-button with lamp symbol | 584117 | 10 |
| | Push-button with pilot lamp | 584118 | 10 |
| | Push-button with bell symbol & pilot lamp | 584119 | 10 |
| | Push-button with lamp symbol & pilot lamp | 584120 | 10 |
| | Push-button with illuminated label holder (w/o symbol) | 584121 | 10 |
| | Push-button with illuminated label holder (with bell symbol) | 584122 | 10 |
| | Push-button with illuminated label holder (with lamp symbol) | 584123 | 10 |
|  | Schuko with child protection (ceramic) | 584151 | 10 |
| | French socket with child protection (ceramic) | 584152 | 10 |
|  | Push-button for shutters & fans | 584124 | 5 |
| | Switch with interlock for shutters | 584130 | 5 |
| Other functions | Key switch (2 positions, 2 NC contacts) | 584140 | 1 |
| | Key switch (3 positions, I-O-II 2 NC contacts) | 584141 | 1 |
| | Emergency push-button (1 NC contact) | 584153 | 1 |
| | Emergency push-button (NO/NC) with key interlock | 584154 | 1 |
| | Emergency push-button (NO/NC) with revolution interlock | 584155 | 1 |
| | Transparent pilot lamp | 584162 | 1 |
| | Red pilot lamp | 584163 | 1 |
| | Green pilot lamp | 584164 | 1 |
| Accessories | Transparent cover for pilot lamp | 584165 | 5 |
| | Red cover for pilot lamp | 584166 | 5 |
| | Green cover for pilot lamp | 584167 | 5 |
| | Lamp 230V, 7W | 584168 | 5 |
| | Lamp 24V, 5W | 584169 | 5 |
| | Double horizontal box | 584300 | 5 |
| | Joint-piece for vertical setup | 584301 | 5 |
| | Single box | 584303 | 10 |
| | Cable entry piece | 584304 | 10 |



Monoblock system

Characteristics

- Clamp mounting in Ø60mm boxes for imbedding in concrete, bare walls or partition walls.
Minimum depth: 40 mm
- Ivory-coloured, heat hardened Monobloc.
- Connector block protected by 2 x 2.5 mm² screws.
- Dimensions: 80 x 80 mm

Conformity to standards

- The switches are manufactured according to:
CEE 7, IEC 669-1, IEC 83, IEC 884-1, NF C 61-110 and NF C 61-601.
- Socket-outlets according to NF C 61-303.

Presentation

Simple lines with gentle curves and subtle colours.

The Porto range will combine with everything in the home.

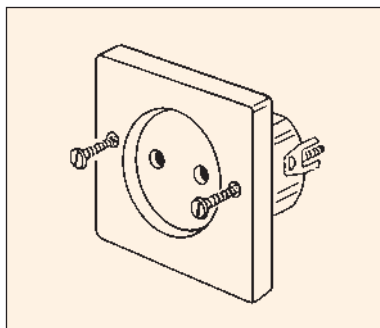

Dimensional drawings ● page A.36
Standards ● page A.32



Switches



| | Colours | | Pack. |
|--------------|-------------|-------------|-------|
| | White 03 | Ivory 06 | |
| Single pole | 582602 | 582500 | 10 |
| Changeover | 582609 | 582510 | 10 |
| Double pole | 582603 | 582515 | 10 |
| Intermediate | 582616 | 582520 | 10 |

Switches with pilot lamp



| | White 03 | Ivory 06 | Pack. |
|------------|-------------|-------------|-------|
| | Single pole | 582601 | |
| Changeover | 582612 | 582512 | 10 |

Double mechanisms



| | Colours | | Pack. |
|-----------------|----------|----------|-------|
| | White 03 | Ivory 06 | |
| 2 x Single pole | 582604 | 582505 | 10 |
| 2 x Changeover | 582614 | 582511 | 10 |

Push-buttons



| | White 03 | Ivory 06 | Pack. |
|------------------------------|----------|----------|-------|
| Single pole without symbol | 582619 | 582550 | 10 |
| Single pole with bell symbol | 582624 | 582551 | 10 |
| Single pole with lamp symbol | 582626 | 582552 | 10 |

Push-buttons with pilot lamp



| | White 03 | Ivory 06 | Pack. |
|------------------------------|----------|----------|-------|
| Single pole without symbol | 582627 | 582553 | 10 |
| Single pole with bell symbol | 582628 | 582554 | 10 |
| Single pole with lamp symbol | 582629 | 582555 | 10 |

Socket-outlet (double pole)



| | White 03 | Ivory 06 | Pack. |
|---|----------|----------|-------|
| Without earth + child protection | 582655 | 582531 | 10 |
| Earth Schuko (standard Germany) | 582642 | 582533 | 10 |
| Earth + child protection (standard France) | 582645 | 582537 | 10 |
| Earth Schuko, screw mounting (standard Germany) | 582660 | 582541 | 10 |

Cable exit



| | White 03 | Ivory 06 | Pack. |
|-----------------------|----------|----------|-------|
| Connection box 3 tags | 582680 | 582560 | 10 |

Telephone socket-outlets



| | White 03 | Ivory 06 | Pack. |
|-----------------------------|----------|----------|-------|
| Telephone (standard France) | 582652 | 582543 | 10 |

TV socket-outlets



| | White 03 | Ivory 06 | Pack. |
|-----------------------------|----------|----------|-------|
| Outlet only TV Ø 9.5 (male) | 582650 | 582545 | 10 |



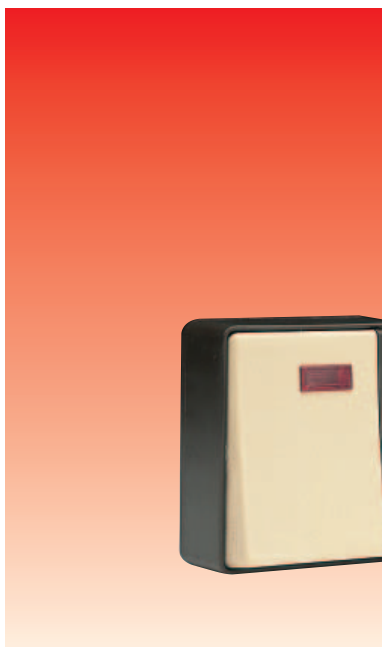

Surface mounting

Characteristics

- Mechanisms for surface mounting.
- Adaptable for trunking systems.
- Ergonomic rockers with a light grey coloured decorative band into the white rockers and a brown band into the light brown rockers.
- Interchangeable decorative bands with other colours. See accessories.
- Pressure mounted rockers.
- Dimensions: 65x60mm.
- 10-16A, 250V socket-outlets.
- Connection: 2 x 2.5mm²

Presentation

The Douro range is a surface mounting range valid for all interiors and requirements.

Douro is personalised with a beautiful grey vertical line which can be interchanged with four other colours.

Easy to install and user friendly.

Two ranges of colours: white and ivory for decoration and renovation.

Standards

According to EN 60 669-1, CEE 7 and IEC 884

Compliance with standards, see page A.32

Switches

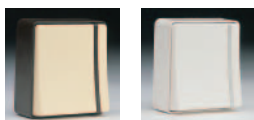

| | Colours | | Pack. |
|--------------|--|---------------------------------|-------|
| | Dark brown base + Light brown rocker | White base + White rocker | |
| Single pole | 584570 | 584550 | 10 |
| Changeover | 584577 | 584557 | 10 |
| Double pole | 584581 | 584562 | 10 |
| Intermediate | 584582 | 584565 | 10 |

Switches with pilot lamp



| | Colours | | Pack. |
|--------------|--|---------------------------------|-------|
| | Dark brown base + Light brown rocker | White base + White rocker | |
| Single pole | 584571 | 584551 | 10 |
| Changeover | 584579 | 584559 | 10 |
| Intermediate | 584583 | 584566 | 10 |

Switches with control lamp



| | Colours | | Pack. |
|-------------|--|---------------------------------|-------|
| | Dark brown base + Light brown rocker | White base + White rocker | |
| Single pole | 584572 | 584552 | 10 |

Double mechanisms

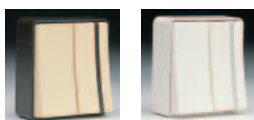

| | Colours | | Pack. |
|-----------------|--|---------------------------------|-------|
| | Dark brown base + Light brown rocker | White base + White rocker | |
| 2 x single pole | 584574 | 584555 | 10 |
| 2 x changeover | 584578 | 584558 | 10 |

Push-buttons



| | Colours | | Pack. |
|------------------------------|--|---------------------------------|-------|
| | Dark brown base + Light brown rocker | White base + White rocker | |
| Single pole without symbol | 584595 | 584561 | 10 |
| Single pole with bell symbol | 584594 | 584568 | 10 |
| Single pole with lamp symbol | 584593 | 584553 | 10 |
| Single pole with key symbol | 584597 | 584554 | 10 |

Push-buttons with pilot lamp



| | Dark brown base + Light brown rocker | White base + White rocker | Pack. |
|------------------------------|--|---------------------------------|-------|
| | Single pole without symbol | 584596 | |
| Single pole with bell symbol | 584623 | 584563 | 10 |
| Single pole with lamp symbol | 584624 | 584564 | 10 |
| Single pole with key symbol | 584625 | 584567 | 10 |

Socket-outlet (double pole)



| | Dark brown base + Light brown rocker | White base + White rocker | Pack. |
|--|--|---------------------------------|-------|
| | Without earth | 584585 | |
| Without earth + child protect. | 584586 | 584521 | 10 |
| Earth Schuko (standard Germany) | 584587 | 584522 | 10 |
| Earth Schuko + child protection | 584588 | 584523 | 10 |
| Earth + child protection (standard France) | 584592 | 584527 | 10 |

Cable exit



| | Dark brown base + Light brown rocker | White base + White rocker | Pack. |
|--|--|---------------------------------|-------|
| | Connection box 3 tags | 584598 | |

Accessories



| | Dark brown base + Light brown rocker | White base + White rocker | Pack. |
|---|--|---------------------------------|-------|
| | Coloured bands | | |
| 4 colours Yellow | | 584537 | 1 |
| Blue | | 584539 | 1 |
| Green | | 584541 | 1 |
| Red | | 584543 | 1 |
| 5 bands of each colour (total 20 bands) | | 584544 | 1 |



Switches and socket-outlets

Compliance with standards

| | | NF (UTE) France | CEBEC Belgium | IPQ Portugal | AENOR Spain | CE marking |
|---------------------------------------|--|--------------------|------------------|-----------------|----------------|---------------|
| SintraPlus | | | | | | |
| Switches | Single pole | • | | • | • | • |
| | Double pole | | | • | • | • |
| | Changeover | • | | • | • | • |
| | Intermediate | | | • | • | • |
| Switches with pilot lamp | Single pole | | | • | • | • |
| | Changeover | • | | • | • | • |
| | Intermediate | | | • | • | • |
| Switches with control lamp | Single pole | | | • | • | • |
| | Changeover | | | • | • | • |
| | Double pole | | | • | • | • |
| Double mechanisms | 2 x single pole | • | | • | • | • |
| | 2 x changeover | • | | • | • | • |
| | Changeover + push-button | | | • | • | • |
| Push-buttons | Single pole | • | | • | • | • |
| Push-buttons with pilot lamp | Single pole | • | | • | • | • |
| Switch for shutters & fans | 2 x changeover for shutters push-buttons | | | • | • | • |
| Socket-outlets | Without earth | | | • | • | N.A. |
| | Without earth + child protection | • | | • | • | N.A. |
| | Earth Schuko (Standard Germany) | | | • | • | N.A. |
| | Earth Schuko + child protection (Standard Germany) | | | • | • | N.A. |
| | Earth Schuko with cover (Standard Germany) | | | • | • | N.A. |
| | Earth + child protection (Standard France) | • | | • | | N.A. |
| Sintra 65 | | | | | | |
| Switches | Single pole | • | • | • | • | • |
| | Double pole | • | • | • | • | • |
| | Changeover | • | • | • | • | • |
| | Intermediate | • | • | • | • | • |
| Switches with pilot lamp | Single pole | • | • | • | • | • |
| | Changeover | • | • | • | • | • |
| | Intermediate | • | • | • | • | • |
| Switches with control lamp | Single pole | • | • | • | • | • |
| | Changeover | • | • | • | • | • |
| | Double pole | • | • | • | • | • |
| Double mechanisms | 2 x single pole | • | • | • | • | • |
| | 2 x changeover | • | • | • | • | • |
| | Changeover + push-button | • | • | • | • | • |
| Push-buttons | Single pole | • | • | • | • | • |
| Push-buttons with pilot lamp | Single pole | • | • | • | • | • |
| Switch for shutters & fans | 2 x changeover for shutters push-buttons | • | • | • | • | • |
| Socket-outlets | Without earth | | | | | |
| | Without earth + child protection | | | | | |
| | Earth Schuko (Standard Germany) | | | | | |
| | Earth Schuko + child protection (Standard Germany) | | | | | |
| | Earth Schuko with cover (Standard Germany) | | | | | |
| | Earth + child protection (Standard France) | | | | | |
| Porto | | | | | | |
| Switches | Single pole | • | | • | | • |
| | Double pole | | | • | | • |
| | Changeover | • | | • | | • |
| | Intermediate | | | • | | • |
| Switches with pilot lamp | Changeover | • | | • | | • |
| Double mechanisms | 2 x single pole | • | | • | | • |
| | 2 x changeover | • | | • | | • |
| Push-buttons | Single pole | • | | • | | • |
| Push-buttons with pilot lamp | Single pole | • | | • | | • |
| Socket-outlets | Without earth + child protection | • | | | | N.A. |
| | Earth Schuko (Standard Germany) | | | • | | N.A. |
| | Earth + child protection (Standard France) | • | | • | | N.A. |
| Douro | | | | | | |
| Switches | Single pole | • | • | • | • | • |
| | Double pole | | • | • | • | • |
| | Changeover | • | • | • | • | • |
| | Intermediate | | | • | • | • |
| Switches with pilot lamp | Single pole | • | | • | • | • |
| | Changeover | • | | • | • | • |
| Double mechanisms | 2 x single pole | • | • | • | • | • |
| | 2 x changeover | • | • | • | • | • |
| Push-buttons | Single pole | • | | • | • | • |
| Push-buttons with pilot lamp | Single pole | • | | • | • | • |
| Socket-outlets | Without earth | | | • | N.A. | N.A. |
| | Without earth + child protection | • | • | • | N.A. | N.A. |
| | Earth + child protection (Standard France) | • | • | • | N.A. | N.A. |

N.A. = Not applicable



Switches and socket-outlets

Douro

Changeover

**Intermediate
Intermediate with pilot lamp**

Changeover

**Push-button
with pilot lamp**

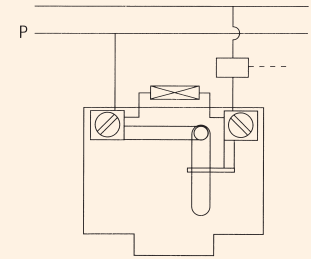
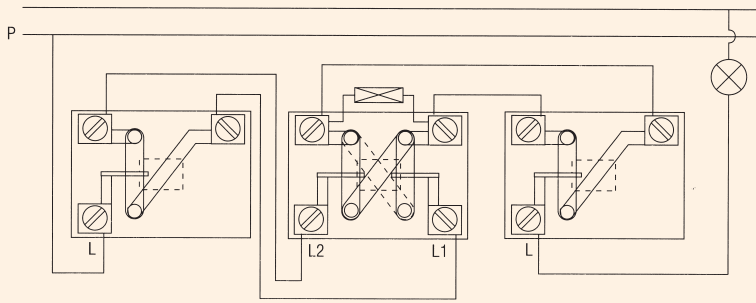

**Push-button
Switch.
With mechanical interlock**

Changeover

**Changeover +
push-button**

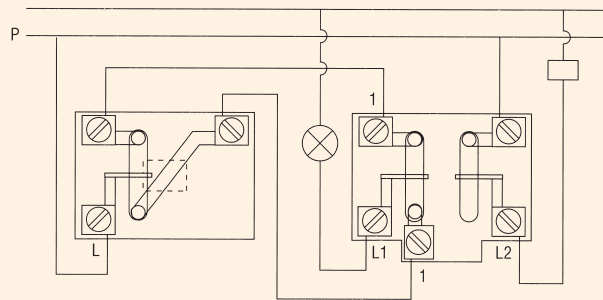
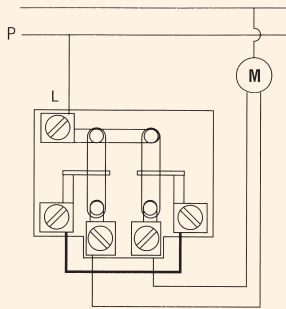

A

Frames for SintraPlus

1 element

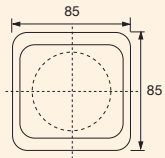

2 elements - vertical

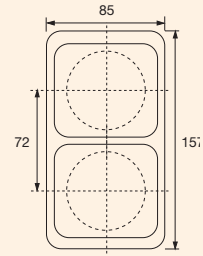

2 elements - horizontal

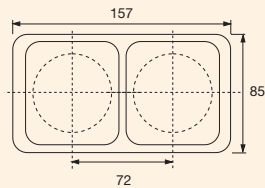

3 elements - vertical

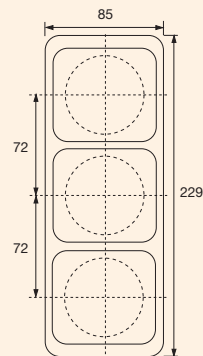

3 elements - horizontal

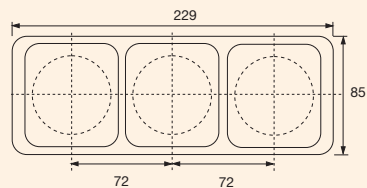

SintraPlus dimmers

Pulse changeover ON/OFF 230V 10-300W (237/53)

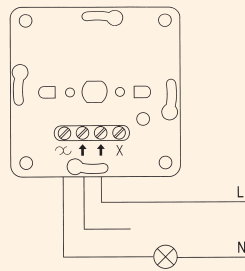

Pulse changeover ON/OFF 230V 40-500W (237/56)

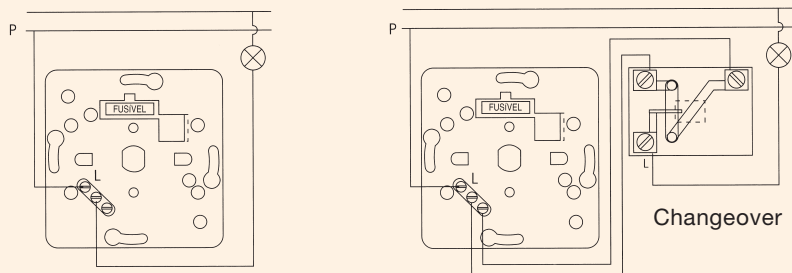

Sensitive pulse switch 230V 40-400W (237/58)

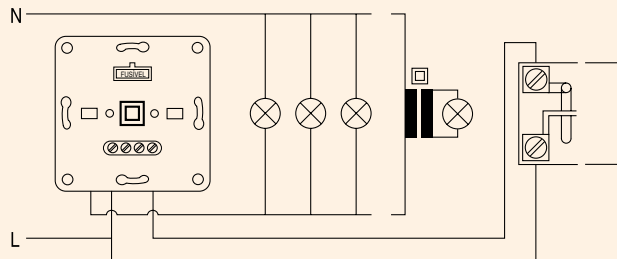

SintraPlus dimmers - technical characteristics

| Types | 237/53 | 237/56 | 237/58 |
|---------------------|--|--|--|
| Line voltage | 230V | 230V | 230V |
| Frequency | 50Hz | 50Hz | 50Hz |
| Load | 10-300VA | 40-500VA | 40-400VA |
| Load type | Incandescent lamps, halogen low voltage, electronic transformers | Incandescent lamps, halogen lamps, conventional transformers | Incandescent lamps, halogen lamps, conventional transformers |
| RFI class | EN 55022 | - | EN 55015 |
| EMC class | - | - | - |
| Fuse | - | F4.0 250V 5x20mm | F4.0 250V 5x20mm |
| Function | Push-button On/Off Rotary potentiometer | Push-button On/Off Rotary potentiometer | To switch the lamp on: Short push switches the lamp on. Longer push will adjust light level. Regulate light intensity: Continuous push increases or decreases light level. Each push toggles the direction light level change. To switch the lamp off: Short push will switch the lamp off. |
| Connectors | 2x2.5mm ² | 2x2.5mm ² | 2x2.5mm ² + 1 auxiliary connector |
| Approvals | DEMKO, FIMKO NEMKO, SEMKO CE marking | CE marking | DEMKO, FIMKO NEMKO, SEMKO CE marking |
| | Dimmer only for incandescent lamps and low voltage halogen lamps with electronic transformer. Do not use with conventional transformers. | | The dimmer works without neutral wire. Can be controlled with one or more extension controllers. |



Porto

Single pole switch

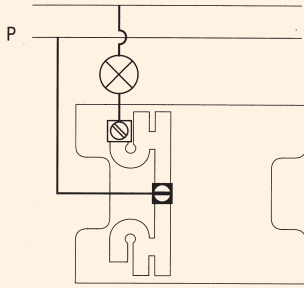

Single pole switch with pilot lamp

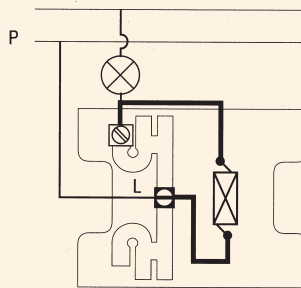

2 x single pole

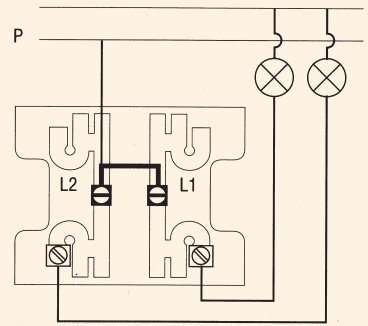

Push-button

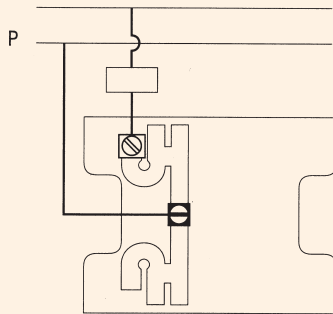

Push-button with pilot lamp

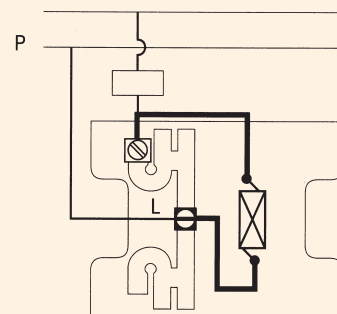

Changeover switch with pilot lamp

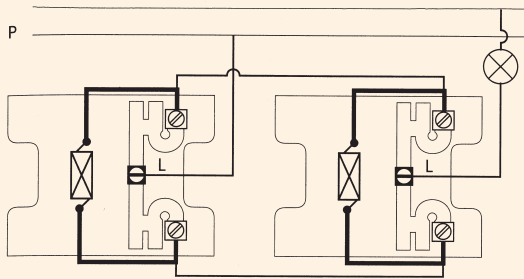

Changeover switches

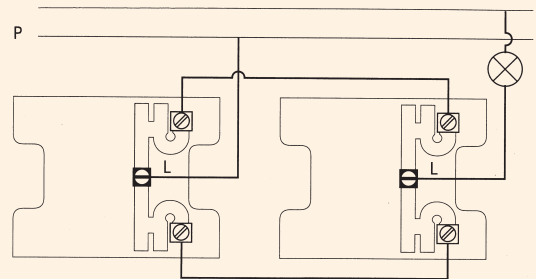

2 x changeover switches

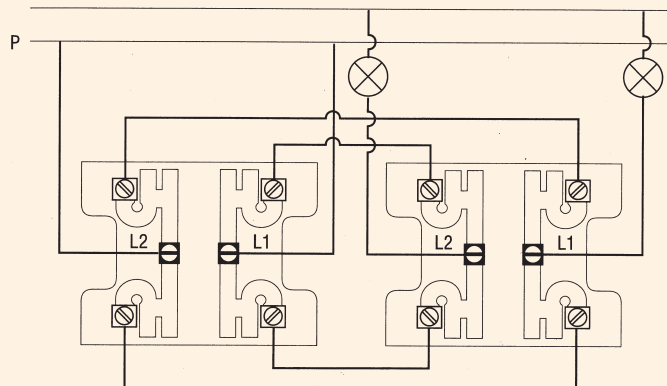

Switches and socket-outlets

Porto

Single pole switch

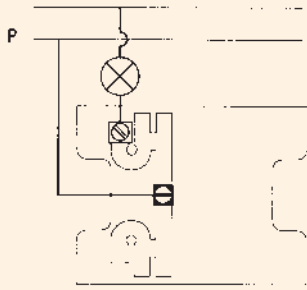

Single pole switch with pilot lamp

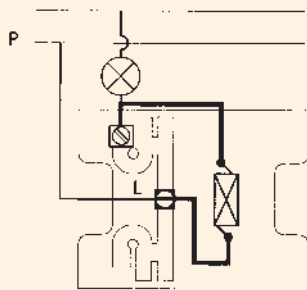

2 x single pole

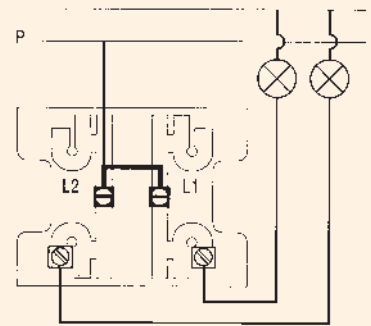

Push-button

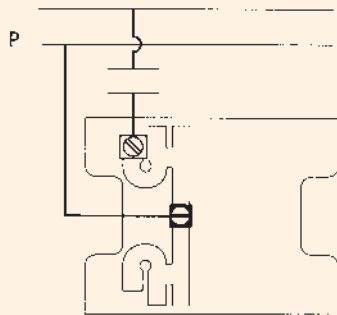

Push-button with pilot lamp

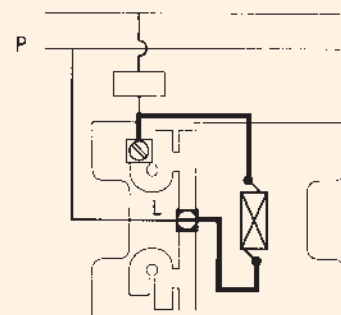

Changeover switch with pilot lamp

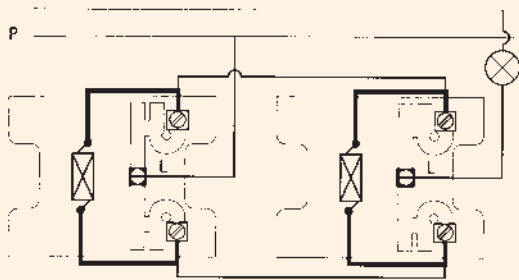

Changeover switches

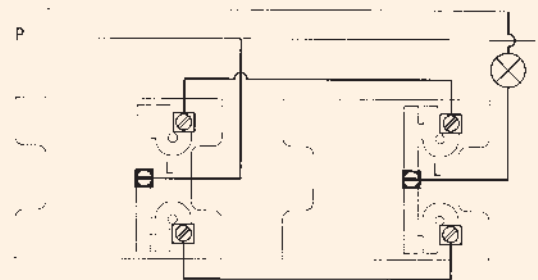

2 x changeover switches

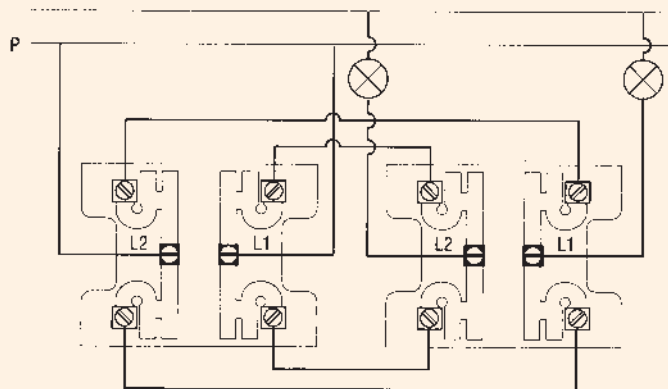

Plugs and socket-outlets

Switches and socket-outlets A

Plugs and socket-outlets 2.5A-32A B

B.2 Plugs and socket-outlets 2.5 - 16A

B.2 Socket-outlets with child protection

B.3 Couplers

Splashproof socket-outlets

B.4 Two and three way plugs

Timers

B.5 Surge arrester with child protection

Residual current device with child protection

Multiple socket-outlet with child protection

B.6 Cable rollers

B.7 Plugs and socket-outlets 16 & 32A

Bells / Cable clamps / Telecommunication C

Junction boxes D

Numerical index X



Plugs and socket-outlets

Plugs 2.5-16A

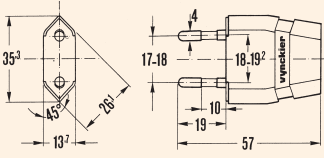
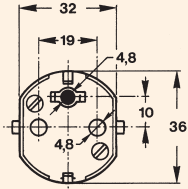
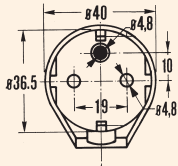
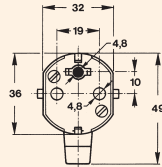
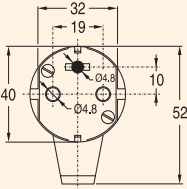
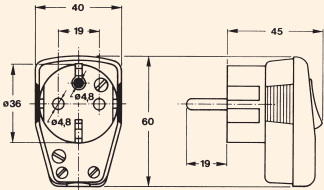
| | 2.5A | | Description | Colour | Ref. No. | Pack. |
|--|---|---|--|----------------|------------------|--------------------|
| |  |  | 2P - 2.5A - 250V 2P - 2.5A - 250V | ivory black | 600620 600621 | 100/900 100/900 |
| | 16A with earth contact Axial cable exit |  | 2P+ ⊕ - 16A - 250V 2P+ ⊕ - 16A - 250V Universal plug with double earth contact (pin and lateral earth contact) | ivory black | 601038 601039 | 50/300 50/300 |
| | Lateral cable exit |  | 2P+ ⊕ - 16A - 250V 2P+ ⊕ - 16A - 250V Two pole universal plug (pin and lateral earth contact) | ivory black | 600603 600604 | 40/240 40/240 |
| | With finger grip and axial cable exit |  | 2P+ ⊕ - 16A - 250V Universal plug with double earth contact (pin and lateral earth contact) | ivory | 601042 | 30/180 |
| | NEW version in rubber |  | 2P+ ⊕ - 16A - 250V 2P+ ⊕ - 16A - 250V | black grey | 698112 698111 | 20 20 |
| | 16A with two pole switch Lateral cable exit |  | 2P+ ⊕ - 16A - 250V 2P+ ⊕ - 16A - 250V with illuminated switch Universal plug with double earth contact (pin and lateral earth contact) | ivory ivory | 601170 601171 | 10 10 |

Socket-outlet with child protection

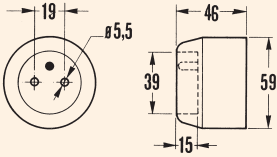
| | | | | | | |
|--|-------------------------------|---|--------------------|-------|--------|----|
| | 16A - surface mounting |  | 2P+ ⊕ - 16A - 250V | ivory | 600617 | 10 |
|--|-------------------------------|---|--------------------|-------|--------|----|

Couplers with child protection

2.5A

Description

Colour

Ref. No.

Pack.

NEW

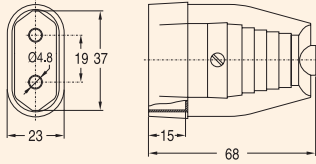

2P - 2.5A - 250V
2P - 2.5A - 250V

ivory
black

600328
600329

40/400
40/400



16A with earth contact

Axial cable exit

NEW

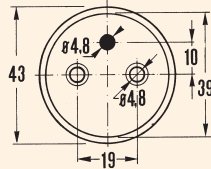

2P+ \oplus - 16A - 250V
2P+ \oplus - 16A - 250V

ivory
black

600330
600331

30/180
30/180



With finger grip and axial cable exit

NEW

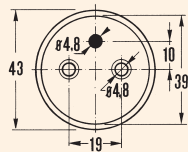

2P+ \oplus - 16A - 250V

ivory

600332

20/120



version in rubber

NEW

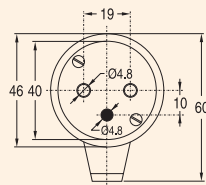

2P+ \oplus - 16A - 250V
2P+ \oplus - 16A - 250V

black
grey

698092
698091

10
10



Splashproof socket-outlet with child protection

IP44-9 \triangle

16A - surface mounting

2P+ \oplus - 16A - 250V

grey

600602

8

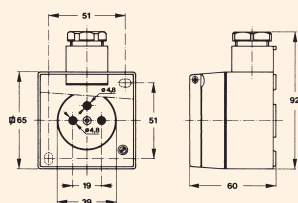

Plugs and socket-outlets

Two way plug 2.5A with child protection

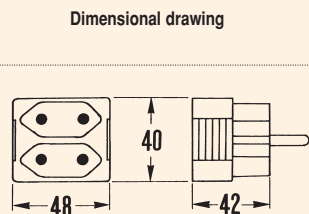

| Description | Colour | Ref. No. | Pack. |
|---------------|--------|----------|-------|
| 2 x 2.5A 250V | ivory | 601188 | 50 |



Three way plug 2.5A with child protection

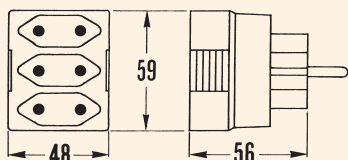

| | | | |
|---------------|-------|--------|----|
| 3 x 2.5A 250V | ivory | 601186 | 20 |
|---------------|-------|--------|----|



Plug-in timers with child protection

Plug-in timers allow to switch appliances on preprogrammed moments.

Analogue timers



Without pointers
CLASSIC 200

- Electronic timer with daily program
- Bistable and undetachable tabs
- Easy programming
- Up to 96 switching commands

651314 1



With pointers
CLASSIC 400

- Electronic timer with daily program
- Bistable and undetachable tabs
- Easy programming
- Up to 96 switching commands
- Equipped with dial

651315 1



CLASSIC 410

- Electronic timer with daily program
- Bistable and undetachable tabs
- Easy programming
- Up to 96 switching commands
- Equipped with pointers
- Protection degree: IP54

651316 1

Digital timer



GALAX 500

- Digital timer with weekly program
- Random function (delays of all switching pulses to 45 min)
- Easy programming
- Summer/winter switches

651317 1

Technical data timers

| | CLASSIC 200 | CLASSIC 400 | CLASSIC 410 | GALAX 500 | | CLASSIC 200 | CLASSIC 400 | CLASSIC 410 | GALAX 500 |
|---------------------|----------------------|-------------|-------------|-----------|-------------------------|-------------|-------------|-------------|--------------|
| Power supply | 220-240 V - 50/60 Hz | | | | Autonomy | - | - | - | 150h (+20°C) |
| Resistive charge | 16A/250V~ | | | | Recharging time battery | - | - | - | 140h |
| Inductive charge | 2.5A/250V~ | | | | Memory allocations | - | - | - | 20 |
| Switching capacity | 3500W | | | | Min. switching time | 15 min. | 15 min. | 15 min. | 1 min. |
| Ambient temperature | | | | | Screen | - | dial | dial | LCD |
| - in service | -5 ... +45°C | | | | Manual switch | yes | yes | yes | yes |
| - peak | -5 ... +55°C | | | | Protection degree | - | - | IP54 | - |

Surge arrester with child protection



| Description | Ref. No. | Pack. |
|--|----------|-------|
| The plug-in surge arrester protects electronic parts of the appliance (Hifi, video, TV, computers etc...) against voltage peaks. These peaks are often generated through near indirect lightning stroke or through switching of electrical motors of refrigerators, burners etc... The surge arrester does not protect the communication devices (data, cable TV, telephone, etc...) | 600063 | 1/10 |

Residual current device 10mA (PRCD) with child protection



| | | |
|---|--------|---|
| The plug-in residual current circuit breaker offers people protection when: - occurring isolation fault with electrical appliances such as laundry machines, drills, lawn mowers and their power cords (indirect contact) - directly touching of voltage carrying parts In case of power loss, the circuit breaker has to be rearmed manually. Provided with cord (1.5 m) and coupler 2P + $\frac{\text{N}}$ - 16A (with pin earthing contact) | 600345 | 1 |
|---|--------|---|

Multiple socket-outlets with child protection

Three outlets 16A

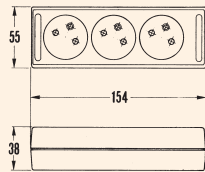

| Description | Colour | Ref. No. | Pack. |
|---|--------|----------|-------|
| 3 x (2P+ $\frac{\text{N}}$ - 16A) 250V | ivory | 600006 | 1/50 |
| 3 x (2P+ $\frac{\text{N}}$ - 16A) 250V With cord 1.5 m and universal plug 600604 | black | 600007 | 1/50 |

Four outlets 16A

Without cord

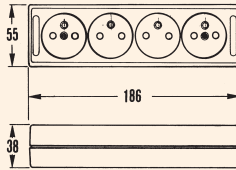

| | | | |
|--|-------|--------|------|
| 4 x (2P+ $\frac{\text{N}}$ - 16A) 250V | ivory | 600009 | 1/50 |
| 4 x (2P+ $\frac{\text{N}}$ - 16A) 250V | black | 600011 | 1/50 |

With cord and plug

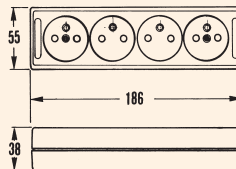

| | | | |
|---|-------|--------|------|
| 4 x (2P+ $\frac{\text{N}}$ - 16A) 250V | ivory | 600013 | 1/50 |
| 4 x (2P+ $\frac{\text{N}}$ - 16A) 250V With cord 1.5 m and universal plug 600604 | black | 600015 | 1/50 |

Seven outlets 2.5-16A

Without cord

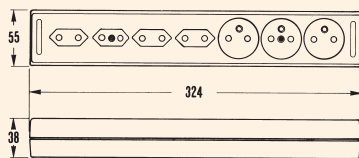

| | | | |
|--|-------|--------|------|
| 4 x (2P 2.5A) + 3 x (2P+ $\frac{\text{N}}$ - 16A) 250V | ivory | 600017 | 1/30 |
| 4 x (2P 2.5A) + 3 x (2P+ $\frac{\text{N}}$ - 16A) 250V | black | 600019 | 1/30 |

With cord and plug

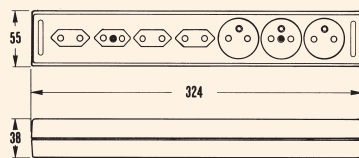

| | | | |
|---|-------|--------|------|
| 4 x (2P 2.5A) + 3 x (2P+ $\frac{\text{N}}$ - 16A) 250V | ivory | 600021 | 1/30 |
| 4 x (2P 2.5A) + 3 x (2P+ $\frac{\text{N}}$ - 16A) 250V With cord 1.5 m and universal plug 600604 | black | 600023 | 1/30 |

Plugs and socket-outlets

Extension cords with child protection

3x1,5 mm² with earth contact



| Description | Colour | Length | Ref. No. | Pack. |
|--|--------|--------|----------|-------|
| - Flexible cord H05 VV-F 3G1.5 with universal plug with pin (601038) and lateral earth contact and coupler (600330) - 2P + \perp 16A 250V | ivory | 2.5 m | 600336 | 1 |
| | black | 2.5 m | 600337 | 1 |
| | ivory | 5 m | 600338 | 1 |
| | black | 5 m | 600339 | 1 |
| - Flexible cord H05 VV-F 3G1.5 with moulded plug and moulded coupler - 2P + \perp 16A 250V | orange | 10 m | 600340 | 1 |
| | orange | 15 m | 600341 | 1 |
| | orange | 25 m | 600342 | 1 |
| | orange | 33 m | 600343 | 1 |
| | orange | 50 m | 600344 | 1 |

Cord box with thermal overload protection with child protection

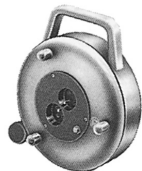

For domestic use

| Dimensional drawing, see page B.6 | Description | Length | Ref. No. | Pack. |
|-----------------------------------|---------------------------------------|--------|----------|-------|
| | - With 2 socket outlets 2P + \perp | 10 m | 600025 | 1 |
| | - With black cable H05 VVF 3 G 1.5 | 15 m | 600027 | 1 |

Garden cable roller with thermal overload protection with child protection



For safe gardening with electrical tools

| Dimensional drawing, see page B.6 | Description | Length | Ref. No. | Pack. |
|-----------------------------------|-----------------------------------|--------|----------|-------|
| | - Yellow cable H05 VVF 3 G 1.5 | empty | 600333 | 1 |
| | | 33 m | 600334 | 1 |
| | | 50 m | 600335 | 1 |

Cable roller with thermal overload protection with child protection



For do-it-yourself and professional application

| Dimensional drawing, see page B.6 | Description | Length | Ref. No. | Pack. |
|-----------------------------------|---|--------|----------|-------|
| | - With 4 socket outlets 2P + \perp - With black cable H05 VVF 3 G 1.5 | empty | 600037 | 1 |
| | | 25 m | 600039 | 1 |
| | | 33 m | 600041 | 1 |
| | | 50 m | 600044 | 1 |

Appliance coupler connector 10A

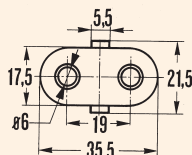

| | | | |
|-----------------------|------|--------|----|
| 2P + \perp 10A 250V | grey | 601172 | 10 |
|-----------------------|------|--------|----|

Cable rollers

Cord box

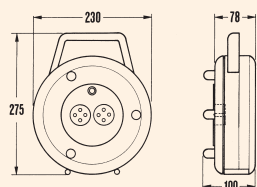

Garden cable roller

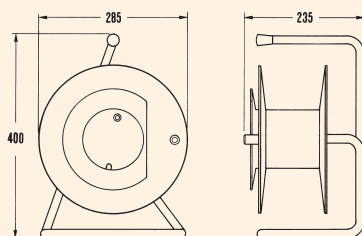

Cable roller

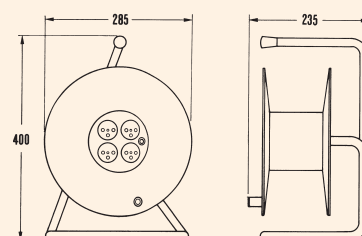



Approvals

Plugs and socket-outlets 16 & 32A are bearing the CEBEC approval mark.

Safety

All plugs and socket-outlets have an earthing contact.

The non-interchangeability of socket-outlets and plugs with different voltage rating of different number of poles is ensured by a starlike relief of the socket-outlet that matches the starlike recess of the plug.

Moreover, a plug of the industrial type (CEE 17) will not engage with a socket-outlet for domestic use. This way both applications are clearly separated. Hence domestic plugs and socket-outlets can also be used in circuits with dual consumers tariffs.

Plugs and socket-outlets 16 & 32A

Because of the steadily increasing power range of domestic appliances such as boilers, electric stoves, washing machines, dish-washers, thermal storage heaters etc... there is a need for multipole plugs and socket-outlets 220/380V with high current ratings. Such plugs and socket-outlets are already in use for industrial purposes and are subjected to severe rules and regulations accepted by most countries (e.g. CEE Publ. 17 and IEC 309).

For domestic purposes, the International Commission on Rules for the Approval of Electric Equipment has issued an identical specifications proposal inspired on the CEE Publication 17 above. The purpose of this proposal is to put an end to the use at random of all kinds of plugs and socket-outlets for 16, 25 and 32A, which only to a certain degree comply with local standards.

The design and construction of our range of plugs and socket-outlets 16 and 32A, 220/380V is entirely in compliance with the specifications of this proposal.

Features

- Aestetical appearance whilst being functional.
- Made of aging resistant moulding materials.
- Plenty of space for wiring.
- Connection: 10 mm².
- High reliability because of the adequate contact pressure.
- Shallow plaster depth, which is important in case of thin walls.
- Extra flat design. Both flush- and surface-type versions project but slightly from the finished surface.
- The hinged cover of the splash-proof fixed socket-outlets opens through 180°.
- Reduced inventory:
 - each socket-outlet can be flush or surface mounted without any modification.
 - the same box for flush or surface mounting can be used for both 16A and 32A current ratings.

Regarding single-phase connections

Some electricity supply companies have taken to the compulsory single-phase connection with a view to simplifying and standardise residential service connections.







It so can happen that monophasic consumer units with current ratings exceeding 32A must be installed.

The CEBEC approved plug 600786 and socket-outlets 600792 and 600798 (2 pole + 380V) because of their wiring capacity, temperature rise and breaking capacity, are guaranteed suitable for loads with a current rating up to 10A.

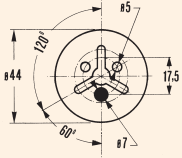

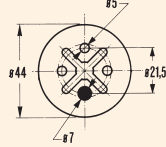

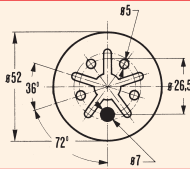

Plugs and socket-outlets

Plugs and socket-outlets

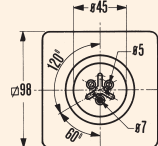

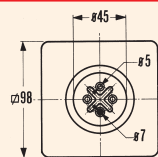

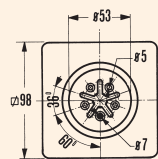

Plugs 16A

| | Dimensional drawing | Description | Colour | Ref. No. | Pack. |
|---|---|---|--------|----------|-------|
|  |  | 2P+ ≙ 16A 230/400V  | grey | 600783 | 10 |
|  |  | 3P+ ≙ 16A 230/400V  | grey | 600784 | 10 |
|  |  | 3P+ N + ≙ 16A 230/400V  | grey | 600785 | 10 |

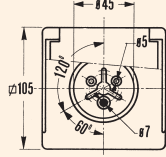

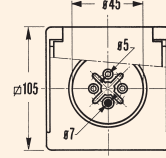

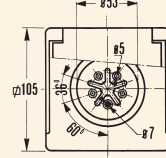

Socket-outlets 16A for flush or surface mounting

| | | | | | |
|---|---|---|------|--------|----|
|  |  | 2P+ ≙ 16A 230/400V  | grey | 600789 | 10 |
|  |  | 3P+ ≙ 16A 230/400V  | grey | 600790 | 10 |
|  |  | 3P+ N + ≙ 16A 230/400V  | grey | 600791 | 10 |

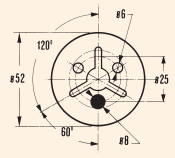

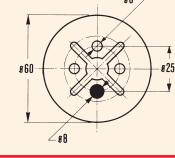

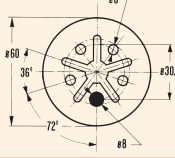

Splashproof socket-outlets 16A for flush or surface mounting Δ IP44

| | | | | | |
|---|---|---|------|--------|----|
|  |  | 2P+ ≙ 16A 230/400V  | grey | 600795 | 10 |
|  |  | 3P+ ≙ 16A 230/400V  | grey | 600796 | 10 |
|  |  | 3P+ N + ≙ 16A 230/400V  | grey | 600797 | 10 |

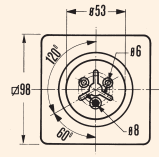

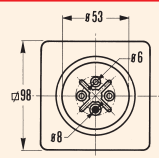

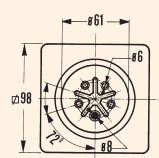

Plugs 32A

| | Dimensional drawing | Description | Colour | Ref. No. | Pack. |
|---|---|---|--------|----------|-------|
|  |  | 2P+ ≐ 32A 230/400V  | grey | 600786 | 10 |
|  |  | 3P+ ≐ 32A 230/400V  | grey | 600787 | 10 |
|  |  | 3P+ N ≐ 32A 230/400V  | grey | 600788 | 10 |

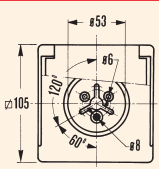
Socket-outlets 32A for flush or surface mounting

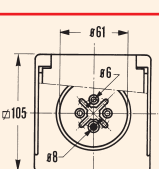
| | | | | | |
|---|---|---|------|--------|----|
|  |  | 2P+ ≐ 32A 230/400V  | grey | 600792 | 10 |
|  |  | 3P+ ≐ 32A 230/400V  | grey | 600793 | 10 |
|  |  | 3P+ N ≐ 32A 230/400V  | grey | 600794 | 10 |

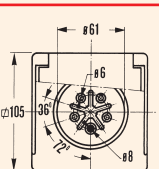
Splashproof socket-outlets 32A for flush or surface mounting Δ IP44

| | | | | | |
|---|---|---|------|--------|----|
|  |  | 2P+ ≐ 32A 230/400V  | grey | 600798 | 10 |
|  |  | 3P+ ≐ 32A 230/400V  | grey | 600799 | 10 |
|  |  | 3P+ N ≐ 32A 230/400V  | grey | 600800 | 10 |

B



Plugs and socket-outlets

Connection box inserts - Fixed wiring of domestic appliances

For flush mounting in 40 mm depth box.

Plugs and socket-outlets

2.5 mm²

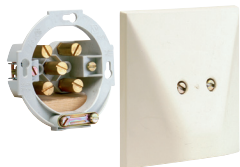

Dimensional drawing

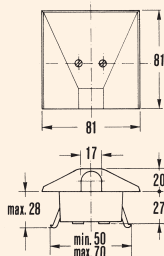

Description

Colour

Ref. No.

Pack.

- 3P + N + \neq 230/400V
- With 5 headed terminals
- 2P + \neq 230/400V
- With 3 headed terminals
- Sealable with two screws 600760.
- To be ordered separately.
- Capacity per terminal:
- 4 x 2.5 mm² 2 x 4 mm²
- 2 x 6 mm² 2 x 10 mm²

ivory

600762

10

ivory

600766

10



6 mm²

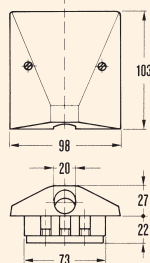
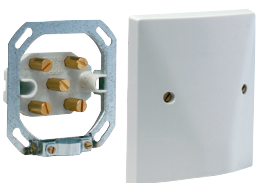

- 3P + N + \neq 230/400V
- With 5 headed terminals
- Capacity per terminal:
- 3 x 4 mm²
- 2 x 6 mm²
- 2 x 10 mm²
- Sealable with two screws 600764.
- To be ordered separately.

grey

600763

10



16 mm²

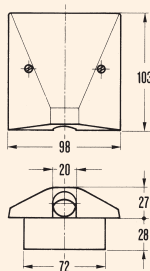

- 2P + \neq 230/400V
- With 3 terminals
- Capacity per terminal:
- 4 x 10 mm²
- 3 x 16 mm²
- Sealable with two screws 600764.
- To be ordered separately.

grey

600765

10



B

Accessories

Surface mounting frame

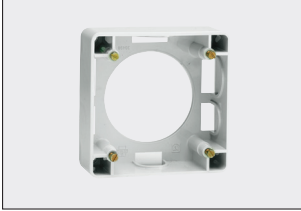

- For socket-outlets 16 & 32A
- For connection box 6 & 16 mm²

600770 10/100

Surface mounting frame with 2 flexible entries (3/4" - 1").

Grey

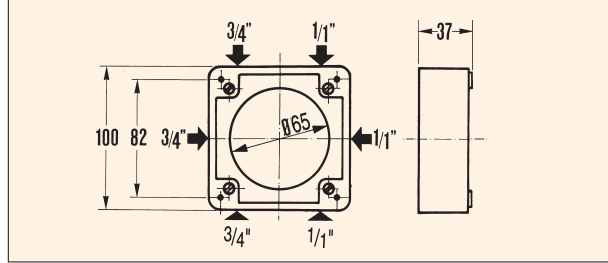

Flush mounting box



- For socket-outlets 16 & 32A
- For splashproof socket-outlets 16 & 32A
- For connection box 6 & 16 mm²

600769 10/100

Flush mounting box with plaster protection plate.

Grey

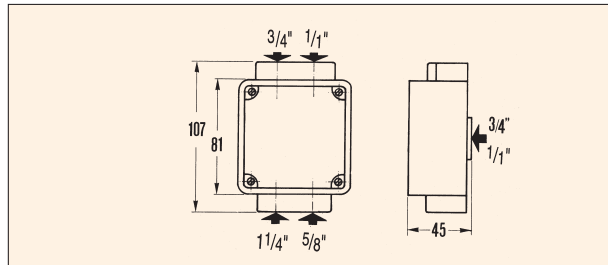

Surface mounting box



- For splashproof socket-outlets 16 & 32A

600767 10

Glands and entries to be ordered separately.

Grey

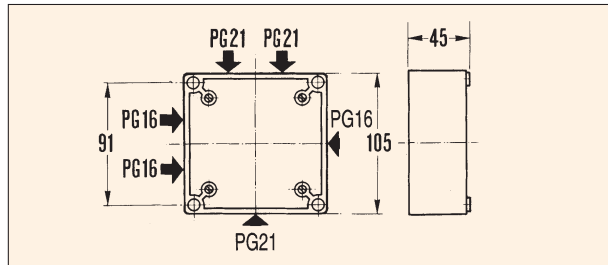

For surface mounting box 600767



Gland

600503 25

PG16
Grey

600504 25

PG21
Grey

Universal cable entry

610130 25

for PG16 hole
Grey

610132 25

for PG21 hole
Grey



Accessories: Sealing screws



Sealing screw

600760 20

for 2.5 mm² box.

Sealing screw

600764 20

for 6 and 16 mm² box.



Notes

B



Switches and socket-outlets A

Plugs and socket-outlets 2.5A-32A B

Bells / Cable clamps / Telecommunication C

- C.2 **Bells**
- C.3 **Push-buttons**
- C.3 **Door contacts**
- C.4 **Cable clamps**
- C.6 **Telecommunication**

Junction boxes D

Numerical index X



Bells

MINI

Nickeled flat chime



Dimensional drawing

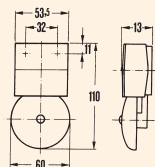

Description

3-6V~
- Volume control by turning the chime
- Interference free

Colour

ivory

Ref. No.

600892

Pack.

1

ALFA

Nickeled flat chime

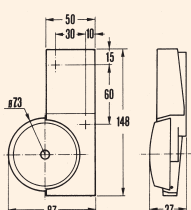

3-6V~
- Volume control by turning the chime
- Interference free

ivory

600890

1

PRIMA I

Nickeled flat chime

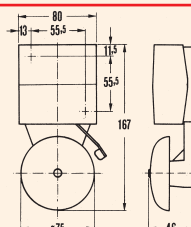

6V~ or 4,5 V =

ivory

600880

1

230V~

ivory

600884

1

PRIMA II

Nickeled chime

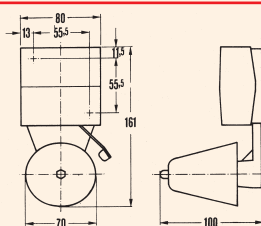

6V~ or 4,5 V =

ivory

600882

1

12V~

ivory

600887

1

24V =

ivory

600888

1

24V~

ivory

600889

1

230V~

ivory

600885

1

PRIMA III

Polished bronze chime

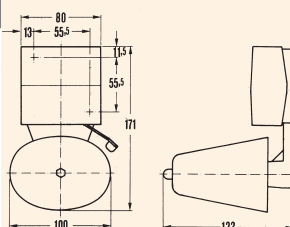

6V~ or 4,5 V =

ivory

600883

1

230V~

ivory

600886

1

Characteristics: Max. 30 sec. in service

| Type | Voltage | Transformer | At rated voltage | | | | | Loudness at 1 meter distance |
|-------------|---------|-------------|------------------|------------------|-----------------|--------|----|------------------------------|
| | | | Resistance | Starting current | Service current | Output | | |
| Ref. No. | | Type | Ω | A | A | VA | dB | |
| Mini | | | | | | | | |
| 600892 | 3V~ | - | | 1 | 0.9 | 2.7 | 75 | |
| | 4V~ | - | 2.5 | 1.3 | 1.2 | 4.8 | 78 | |
| | 6V~ | 8VA | | 2 | 1.85 | 8 | 80 | |
| Alfa | | | | | | | | |
| 600890 | 3V~ | - | | 1 | 0.9 | 2.7 | 75 | |
| | 4V~ | - | 2.5 | 1.3 | 1.2 | 4.8 | 78 | |
| | 6V~ | 8VA | | 2 | 1.85 | 8 | 80 | |

Characteristics: Unlimited service

| Type | Voltage | Transformer | At rated voltage | | | | | Loudness at 1 meter distance |
|------------------|---------|-------------|------------------|------------------|-----------------|--------|----|------------------------------|
| | | | Resistance | Starting current | Service current | Output | | |
| Ref. No. | | Type | Ω | A | A | VA | dB | |
| Prima I | | | | | | | | |
| 600880 | 6V~ | 8VA | 4 | 0.75 | 0.45 | 2.7 | 70 | |
| | 4,5V = | - | | 1.2 | 0.6 | 2.7W | 76 | |
| 600884 | 230V~ | - | 3300 | 0.04 | 0.02 | 4.4 | 76 | |
| Prima II | | | | | | | | |
| 600882 | 6V~ | 8VA | 4 | 0.75 | 0.45 | 2.7 | 79 | |
| | 4,5V = | - | | 1.2 | 0.6 | 2.7W | 82 | |
| 600887 | 12V~ | 5VA | 15 | 0.3 | 0.2 | 2.4 | 74 | |
| 600888 | 24V = | - | 300 | 0.08 | 0.06 | 1.5W | 76 | |
| 600889 | 24V~ | 12VA | 40 | 0.3 | 0.2 | 4.8 | 79 | |
| 600885 | 230V~ | - | 3000 | 0.04 | 0.02 | 4.4 | 79 | |
| Prima III | | | | | | | | |
| 600883 | 6V~ | 8VA | 4 | 0.75 | 0.45 | 2.7 | 85 | |
| | 4,5V = | - | | 1.2 | 0.6 | 2.7W | 92 | |
| 600886 | 230V~ | - | 3000 | 0.04 | 0.02 | 4.4 | 88 | |

Push-buttons

SURFACE MOUNTING



Without name plate

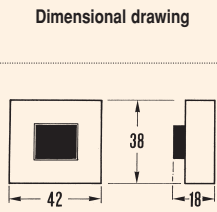

| Description | Contacts | Colour | Ref. No. | Pack. |
|-----------------------------|----------|--------|----------|-------|
| - Service voltage up to 48V | 1NO | ivory | 600894 | 10 |



With name plate

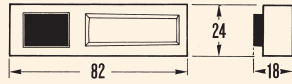

| | | | | |
|-----------------------------|-----|-------|--------|----|
| - Service voltage up to 48V | 1NO | ivory | 600898 | 10 |
|-----------------------------|-----|-------|--------|----|



With illuminated name plate

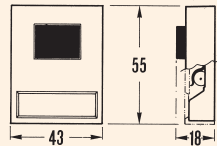

| | | | | |
|-----------------------|-----|-------|--------|----|
| - For 6V transformer | 1NO | ivory | 600899 | 10 |
| - For 12V transformer | 1NO | ivory | 600902 | 10 |
| - With bulb 1W | | | | |



With bulb 1W

| | | | | |
|-----------------------|---|--|--------|--------|
| - For 6V transformer | - | | 600900 | 10/100 |
| - For 12V transformer | - | | 600901 | 10/100 |

FLUSH MOUNTING

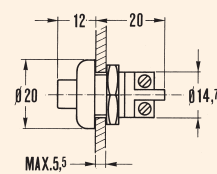

| | | | | |
|--|-----|-------|--------|----|
| - Permissible current 0.5A at 24V \equiv 1A at 230V~ | 1NO | black | 600895 | 20 |
|--|-----|-------|--------|----|

Door contacts

SURFACE MOUNTING

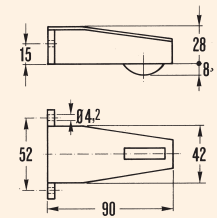

| | | | | |
|------------------------------|-----|-------|--------|----|
| - Service voltage up to 250V | 1NO | brown | 600897 | 10 |
|------------------------------|-----|-------|--------|----|

FLUSH MOUNTING

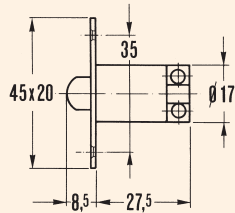

| | | | | |
|--|-----|-------|--------|----|
| - Permissible current 1A at 24V \equiv 2A at 230V~ | 1NC | black | 600896 | 10 |
|--|-----|-------|--------|----|

Cable clamps

Thermoplastic cable clamps

- Base foreseen at both sides of two dovetails
- Unloosable screws included
- All clamps at the same width
- Version with inox screws

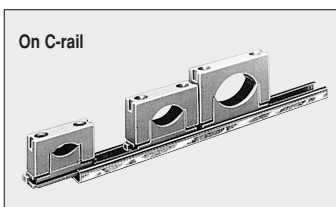



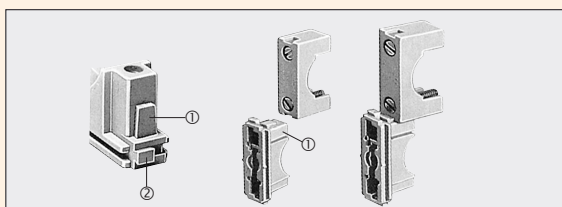

With M6-nail

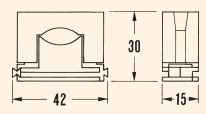
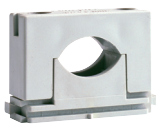
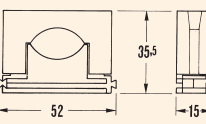

- ① Dovetail permitting waiting position of hood on base.
 ② Dovetail permitting click-on fixing (all types mutual).

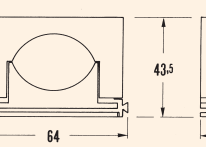
Wiring devices

| | Dimensional drawings | Description | Colour | Ref. No. | Pack. |
|---|--|--------------------------------------|--------|---------------|---------|
|  |  | For cable Ø 8 up to Ø 20 mm | | | |
| | | with standard screws | grey | 600935 | 100/900 |
| | | with inox screws | grey | 600938 | 100/900 |
|  |  | For cable Ø 14 up to Ø 26 mm | | | |
| | | with standard screws | grey | 600936 | 60/540 |
| | | with inox screws | grey | 600939 | 60/540 |
|  |  | For cable Ø 24 up to Ø 38 mm | | | |
| | | with standard screws | grey | 600937 | 40/360 |
| | | with inox screws | grey | 600940 | 40/360 |
| <p>Suspension clamps for aerial lines</p>  <p>To convert standard clamps into clamps for aerial lines.</p> | | | | | |
| | | For cable clamps | black | 601220 | 25 |
| | | 600935 600938 | ① | | |
| | | For cable clamps | black | 601221 | 25 |
| | | 600936 600939 600937 600940 | ② | | |

Accessories

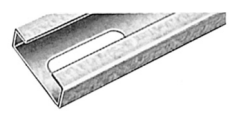
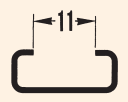
| | Dimensional drawing | Description | Ref. No. | Pack. |
|---|---|---------------|---------------|-------|
|  <p>C-Rail</p> | | Length 490 mm | 600930 | 1 |
| |  | | | |

Snap-on clips series Tub-o-Click

Ref. No. Pack.

- To snap flexible and firm plastic and metal tubes with two different diameters
- Can be fixed with plug and screw or is self tapping on impact plug M6
- With keyhole to fix the lateral placement
- Can be slid into C-rail with opening of 11mm
- All snap-on clips have the same width
- The base of all types is fitted at each side with a swallow tail



| | | | | | | |
|-----------------|--------|----------|--------|----------|--------|----------|
| For tube 5/8" | PG9 | IRO 13.5 | IEC 16 | 15-16 mm | 600300 | 100/1000 |
| For tube 3/4" | PG11 | IRO 16 | | 18-19 mm | 600301 | 100/1000 |
| For tube - | PG13.5 | IRO 19 | IEC 20 | 20-21 mm | 600302 | 100/1000 |
| For tube 1" | | IRO 23 | IEC 25 | 25-26 mm | 600304 | 100/1000 |
| For tube 1 1/4" | | IRO 29 | IEC 32 | 31-32 mm | 600306 | 50/500 |
| For tube 1 1/2" | PG29 | - | - | 37-38 mm | 600307 | 50/500 |
| For tube 2" | PG42 | - | - | 50-51 mm | 600309 | 25/250 |

Accessories

Dimensional drawing

Description

Ref. No.

Pack.

C-rail

Length 490 mm

600930

1

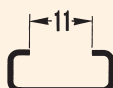
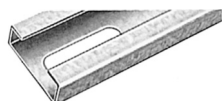



Telephone connector junction boxes

Indoor connector boxes and cabinets

Boxes are composed of a flat base and a removable cover

- The base is equipped with screw terminal strips.
- The cover can be sealed for the versions higher than 20 pairs.
- Raw material:
 - ABS: boxes up to 40 pairs
 - Metal sheet steel: cabinets 80 and 120 pairs.
- Protection degree: IP30
- Flush mounting.

Terminal strips

A terminal strip consists of an insulated body in grey thermoplastic material and of through terminals and one earth terminal mounted into the moulding.

Standard connections

Screwed connections: the fixing is performed with nickel-plated brass connections which guide and grip the conductor positively into the correct position.

Soldered connections

The soldering wire wrapping is done to a lug in tin-plated brass.









- Two types:
- the single-row terminal strip of 10 pairs (20 through terminals)
 - the double-row strip with 20 pairs (i.e. 40 through terminals).

Both versions allow for either screwed or soldered connection and any possible combination thereof. The whole range amounts to 18 different terminal strips.

Combi-type wire guides in right-angled and flat patterns greatly simplify the passage and the positioning of the conductors.

Each terminals strip can take up to two markerholders.

Terminal strips

| | 10 PAIRS | | Description | Ref. No. | Pack. |
|---|---|---|---|----------|-------|
|  |  | - Insulated body in grey thermoplastic material | - Connection by screws ⁽¹⁾ | 602731 | 10 |
| |  | - 20 through terminals + 1 earth terminal ⁽³⁾ | - Connection by screws and soldering ⁽²⁾ | 602732 | 10 |
|  |  | - Insulated body in grey thermoplastic material | - Connection by screws ⁽¹⁾ | 602708 | 10 |
| |  | - 20 through terminals + 1 earth terminal ⁽³⁾ | - Connection by screws and soldering ⁽²⁾ | 602733 | 10 |
| CONNECTION POSSIBILITIES | | | | | |
| |  | (1) Connection by screws 2 sides ⁽³⁾ | | | |
| |  | (2) Connection by screws and/or wiring-wrapping or soldering 2 sides ⁽³⁾ | | | |

(3) Dimensional drawings, see page C.8







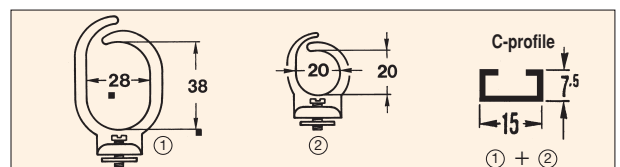

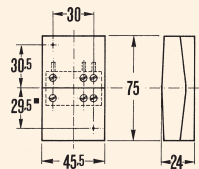

Accessories: ring with screw and nut for DIN-rail mounting

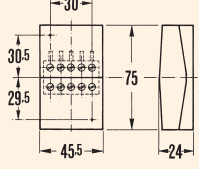

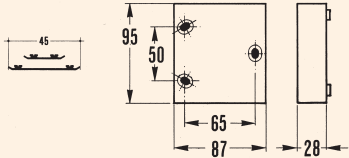
| | | |
|-------|--------|----|
| | 602703 | 25 |
| black | ① | |
| | 602704 | 25 |
| black | ② | |

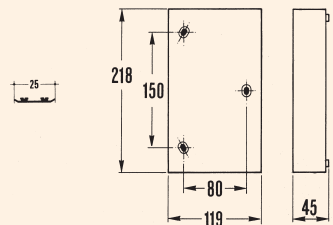

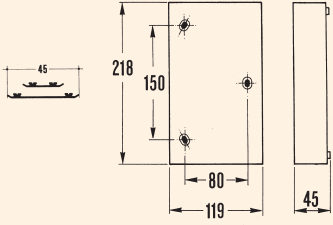
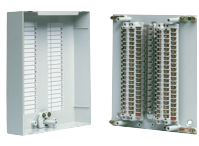
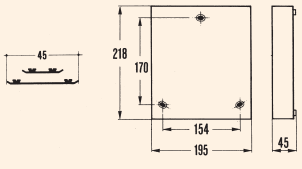
Connector boxes

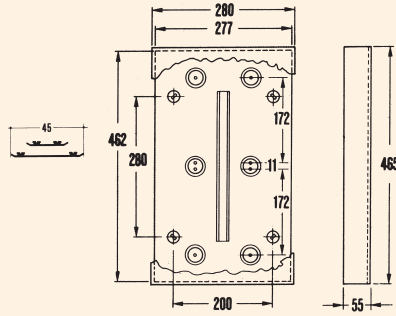
| 1 PAIR | Dimensional drawings | Description | Ref. No. | Pack. |
|---|---|---|----------|-------|
|  |  | Equipped with: - 2 through terminals - 1 earth terminal - connection by screws 2 sides Thermoplastic material: - cover: ivory - base: black | 602707 | 20 |
|  |  | Equipped with: - 4 through terminals - 1 earth terminal - connection by screws 2 sides Thermoplastic material: - cover: ivory - base: black | 602706 | 20 |
|  |  | Equipped with: - 12 through terminals - 1 earth terminal - connection by screws 2 sides Thermoplastic material: cover and base: grey | 602713 | 10 |
|  |  | Equipped with: - 1 terminal strip of 20 through terminals - 1 earth terminal - connection by screws 2 sides Thermoplastic material: cover and base: grey | 602734 | 1/10 |
|  |  | Equipped with: - 1 terminal strip of 40 through terminals - 1 earth terminal - connection by screws 2 sides Thermoplastic material: cover and base: grey | 602714 | 1/10 |
|  |  | Equipped with: - 2 terminal strips of each 40 through terminals - 2 earth terminals - connection by screws 2 sides Vertical cable trunking between the strips enables jumpering. Cover is sealable Thermoplastic material: cover and base: grey | 602715 | 1/10 |
|  |  | Equipped with: - 4 terminal strips of each 40 through terminals - 4 earth terminals - connection by screws 2 sides Vertical cable trunking between the strips enables jumpering. Cover is sealable Cover and base: sheet steel Cover: grey - epoxy-coated Base: black - epoxy-coated | 602716 | 1 |

Connector boxes (continued)

120 PAIRS

Dimensional drawing

Description

Ref. No.

Pack.

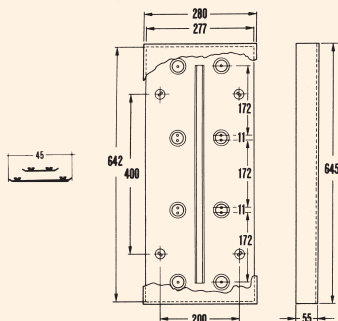
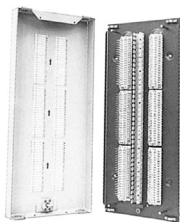

Equipped with:
 - 6 terminal strips of each 40 through terminals
 - 6 earth terminals
 - connection by screws 2 sides
 Vertical cable trunking between the strips enables
 jumpering.
 Cover is sealable.
 Cover and base: sheet steel
 Cover: grey - epoxy-coated
 Base: black - epoxy-coated

602717

1

Empty connector boxes

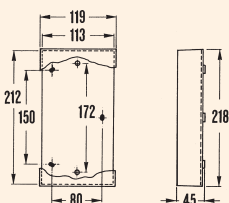

Equipped with:
 - 1 terminal strip of 10 pairs or
 - 1 terminal strip of 20 pairs
 Thermoplastic material:
 cover and base: grey

602735

1

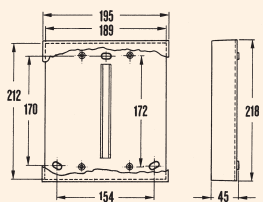
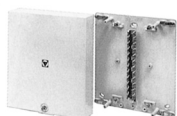

Equipped with:
 2 terminal strips x 10 pairs or
 2 terminal strips x 20 pairs or
 a combination of both strips
 With cable trunking between the strips
 With sealable cover
 Thermoplastic material:
 cover and base: grey

602736

1

C

Terminal strips

10 pairs

20 pairs

Connection possibilities

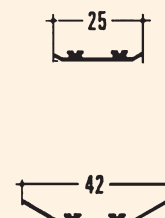
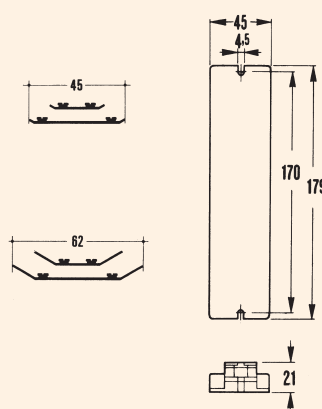
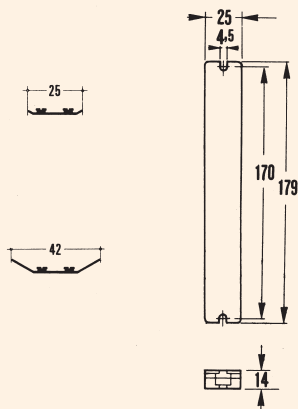

Switches and socket-outlets A

Plugs and socket-outlets 2.5A-32A B

Bells / Cable clamps / Telecommunication C

Junction boxes D

D.2 **Flex-o-Box**

D.4 **Series 55**

Numerical index X





Flex-o-Box

IP65



Approvals / Marking



Features

Flex-o-Box Junior

Technical data

- Suitable for surface mounting
- 2.5 mm² - 500V
- IP65 protection degree
- Standards and approvals
CEBEC: NBN C 68-685-2-0
NBN C68-685-1
VDE: 0606 Teil1
KEMA: IEC 670
- Colour: RAL 7035
- Material: resists the 750°C incandescent wire test
- Halogen-free
- Operating temperature: -5°C to +60°C
- Total insulation: ☐

Eight flexible entries

- 7 x Ø 20 in the side wall
- 1 x Ø 20 in the back
- Suitable for cable max. Ø 20
- Suitable for tubes 5/8" and 3/4"

Flex-o-Box JB⁶

Technical data

- Suitable for surface mounting
- 6 mm² - 500V
- IP65 protection degree
- Standards and approvals:
CEBEC: NBN C68-685-2-0
NBN C68-685-1
VDE: 0606,
KEMA: IEC 670
- Colour: RAL 7035
- Material: resists the 750°C incandescent wire test
- Halogen-free
- Operating temperature: -5°C to +60°C
- Total insulation: ☐

Nine flexible entries

- 7 x PG16 in the side wall
- 2 x Ø 20 mm max. entries in the back of the base
- Suitable for cable max. Ø 20
- Suitable for tubes 5/8" and 3/4"
- Suitable for cable seals (8 mm min. thread length)

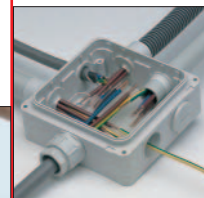
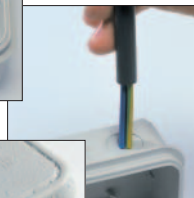
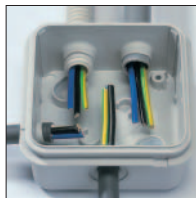

Dimensions ● page D.7

Flex-o-Box



Junior

| | Ref. No. | Pack. |
|--|----------|--------|
| Junction box 2.5 mm ² | 600656 | 10/100 |
| Junction box 2.5 mm ² (40 pieces in a red polybox basket) | 600311 | 1 |



JB⁶

| | | |
|---|--------|--------|
| Junction box 6 mm ² | 600651 | 10/100 |
| Junction box 6 mm ² (24 pieces in a grey polybox basket) | 600310 | 1 |



Accessories

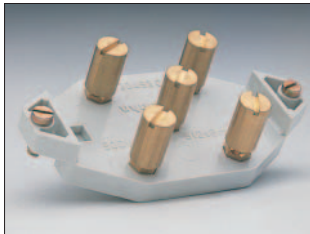

for Junior and JB⁶

Terminal block

| | |
|--------------------------------------|------------------------|
| 600950 | 30 |
| 10 mm ² - 500V - pin-type | |
| 5-terminal blocks | |
| Possible connections per terminal: | |
| 6 x 1.5 mm ² | 2 x 6 mm ² |
| 4 x 2.5 mm ² | 2 x 10 mm ² |
| 3 x 4 mm ² | |
| grey | |

only for JB⁶

Cable seal

| | |
|-----------|----|
| 851046 | 50 |
| PG16 grey | |

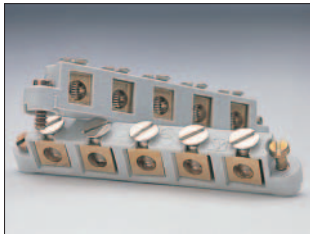
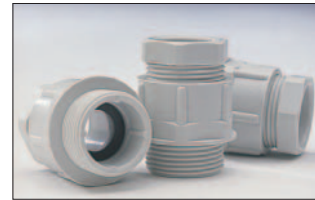

Terminal strip

| | |
|--------------------------------------|-----------------------|
| 600650 | 1 |
| 6 mm ² - 500V - hole-type | |
| 5-terminal strips | |
| Possible connections per terminal: | |
| 6 x 1.5 mm ² | 3 x 4 mm ² |
| 4 x 2.5 mm ² | 2 x 6 mm ² |
| grey | |

Entry socket for tube

| | |
|-------------------------|--------|
| 600933 | 25/300 |
| PG16 for tube 5/8" grey | |
| 600934 | 25/300 |
| PG16 for tube 3/4" grey | |
| for tube ø 16 mm | |
| for tube ø 20 mm | |



Insulated cap

| | |
|-----------|----|
| 600945 | 25 |
| PG16 grey | |



Screws

| | |
|---------------------|----|
| For cover fastening | |
| 600652 | 40 |
| Stainless steel | |





Series 55

IP66

Approval



Applications

- As an empty box
- As a junction box (10/16/25 mm²)
- Coupled

Features

- Standard: IEC 529
- Material: thermoplastic high impact polyphenylene oxyde
- Total insulation: □

Dimensions

Three sizes - three types

55100 - 125 x 125 x 75 mm

55200 - 175 x 175 x 95 mm

55300 - 225 x 175 x 95 mm

Benefits

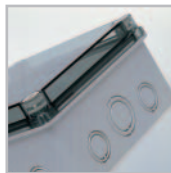

The cable entries are selective knockouts placed as close as possible to the wall.

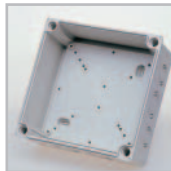

Oval openings in the base allow levelling. Four fixing holes outside the gasket and two fixing holes inside the box.



The raised bottom avoids obstruction while cabling and bending of the cables.



Raised supports for the placement of the mounting plate.



The screws are thermoplastic, captive, full turn, with a big pitch and placed outside the gasket.



All the boxes are sealable.

Series 55100 - 10 mm² ☐ IP66 - IK07



| Cover | Entries | Characteristics | Ref. No. | Pack. |
|-------|--------------|--|----------|-------|
| grey | 5 x PG 16/21 | Empty. Can be equipped with terminal blocks 600516 | 600514 | 1/16 |
| grey | 5 x PG 16/21 | Equipped with terminal blocks 600516: 5 clamps with maximum capacity: 5 x 4 mm ² / 4 x 6 mm ² / 3 x 10 mm ² | 600515 | 1/16 |

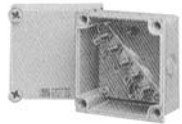

Series 55200 - 16 mm² ☐ IP66 - IK07



| Cover | Entries | Characteristics | Ref. No. | Pack. |
|-------------|------------------------------|---|----------|-------|
| grey | 6 x PG 16/21 5 x PG 21/29 | Empty. Can be equipped with terminal blocks 600525 600526 (x5) 600544 (x5) 600545 (x5) 600516 | 600517 | 1/9 |
| grey | 6 x PG 16/21 5 x PG 21/29 | Equipped with terminal blocks 600525: 5 clamps with maximum capacity: 5 x 6 mm ² / 4 x 10 mm ² / 3 x 16 mm ² | 600524 | 1/9 |
| transparent | 6 x PG 16/21 5 x PG 21/29 | Empty | 600523 | 1/9 |

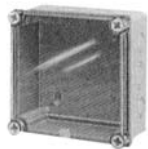
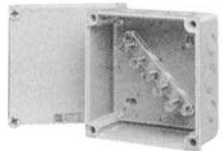

Series 55300 - 25 mm² ☐ IP66 - IK09

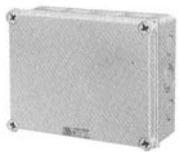

| Cover | Entries | Characteristics | Ref. No. | Pack. |
|-------------|---------------------------|--|----------|-------|
| grey | 8 x PG 21 6 x PG 21/29 | Empty. Can be equipped with terminal blocks 600544 (x5) 600545 (x5) 600525 600526 (x5) | 600532 | 1/9 |
| grey | 8 x PG 21 6 x PG 21/29 | Equipped with terminal blocks 600544 (x5): 5 clamps/nuts with maximum capacity: 4 x 16 mm ² / 3 x 25 mm ² / 2 x 35 mm ² | 600543 | 1/9 |
| transparent | 8 x PG 21 6 x PG 21/29 | Empty | 600539 | 1/9 |

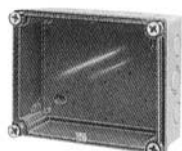
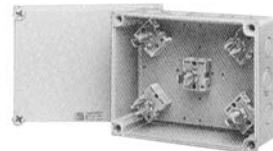

Accessories



Terminal blocks 500V 10 mm²

| | |
|--------|-----|
| 600516 | 1/6 |
|--------|-----|

Set terminal blocks with two fixation screws. With five clamps suitable for Al or Cu connection.

Maximum cable section per clamp:
5 x 4 mm² / 4 x 6 mm² / 3 x 10 mm².

Can be fitted in types 55100 and 55200.

Couplings

| | |
|--------|---|
| 600509 | 1 |
|--------|---|

Set of two pieces

PG21

It is possible to combine types
55200 and 55300



Terminal blocks 500V 16 mm²

| | |
|--------|-----|
| 600525 | 1/6 |
|--------|-----|

With five clamps, suitable for Al or Cu connection.

Maximum cable section per clamp:
5 x 6 mm² / 4 x 10 mm² / 3 x 16 mm².

Can be fitted in types 55200 and 55300.

Compression glands

| | |
|--------|----|
| 600504 | 25 |
|--------|----|

PG21 with nut in glass fibre reinforced polyamide. Grey.

| | |
|--------|----|
| 600505 | 25 |
|--------|----|

PG29 with nut in glass fibre reinforced polyamide. Grey.



Terminal blocks 500V 16 mm²

| | |
|--------|------|
| 600526 | 1/24 |
|--------|------|

With one clamp/nut (with nut), suitable for Al or Cu connection.

Maximum cable section per clamp:
5 x 6 mm² / 4 x 10 mm² / 3 x 16 mm².

Can be fitted in types 55200 and 55300.

Compression glands

| | |
|--------|----|
| 600501 | 25 |
|--------|----|

PG21 polyamide with nut in glass fibre reinforced polyamide. Brown.

| | |
|--------|----|
| 600502 | 25 |
|--------|----|

PG29 polyamide with nut in glass fibre reinforced polyamide. Brown.



Terminal blocks 500V 25 mm²

| | |
|--------|------|
| 600544 | 1/24 |
|--------|------|

With one clamp/nut (with nut), suitable for Al or Cu connection.

Maximum cable section per clamp:
4 x 16 mm² / 3 x 25 mm² / 2 x 35 mm².

Can be fitted in types 55200 and 55300.

Locknuts

| | |
|--------|-----|
| 600506 | 100 |
|--------|-----|

Nut in glass fibre reinforced polyamide to connect compression glands PG21. Grey.

| | |
|--------|----|
| 600507 | 50 |
|--------|----|

Nut in glass fibre reinforced polyamide to connect compression glands PG29. Grey.



Terminal blocks 500V 25 mm²

| | |
|--------|------|
| 600545 | 1/24 |
|--------|------|

With one clamp/nut (double nut), suitable for Al or Cu connection.

Maximum cable section per clamp:
4 x 16 mm² / 3 x 25 mm² / 2 x 35 mm².

Can be fitted in types 55200 and 55300.

Universal entries (grey)

| | |
|--------|----|
| 610130 | 25 |
|--------|----|

Cable max. 18 mm, drill 23 mm, PG16

| | |
|--------|----|
| 610132 | 25 |
|--------|----|

Cable max. 24 mm, drill 29 mm, PG21

| | |
|--------|----|
| 610133 | 25 |
|--------|----|

Cable max. 32 mm, drill 38 mm, PG29.



Insulated cap

| | |
|--------|----|
| 890838 | 48 |
|--------|----|

Suitable for terminal blocks

600526

600544

600545

Safety wrench

| | |
|--------|---|
| 601222 | 1 |
|--------|---|

Insulation up to 1000V

Orange.



Junction box - Flex-o-Box

Flex-o-Box Junior

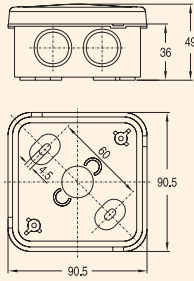

Flex-o-Box JB⁶

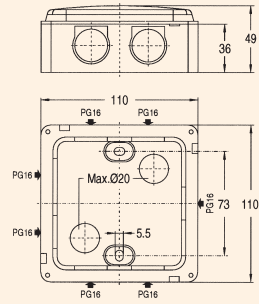

Junction box - Series 55

Series 55100

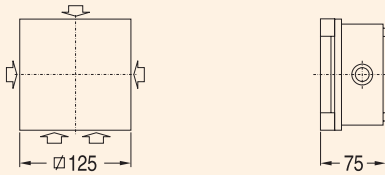

Series 55300

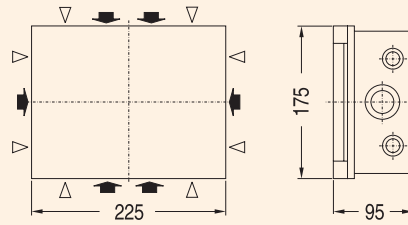

Series 55200

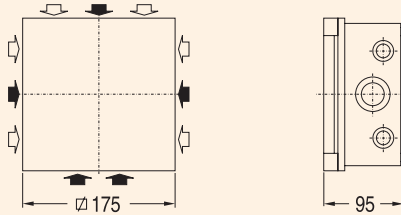

- ▽ PG 21
- ◻ PG 16/21
- ◼ PG 21/29

Numerical index

| Ref. No. Page | Ref. No. Page | Ref. No. Page | Ref. No. Page | Ref. No. Page | Ref. No. Page | Ref. No. Page | Ref. No. Page | Ref. No. Page | Ref. No. Page |
|---------------|---------------|---------------|---------------|---------------|---------------|---------------|---------------|---------------|---------------|
| 286... | 584116 A.27 | 584685 A.8 | 585289 A.10 | 586331 A.14 | 586954 A.18 | 587187 A.16 | 587462 A.18 | 587702 A.16 | |
| 286050 A.10 | 584117 A.27 | 584687 A.8 | 585290 A.11 | 586332 A.14 | 586955 A.18 | 587188 A.16 | 587463 A.18 | 587703 A.16 | |
| 510... | 584118 A.27 | 584688 A.8 | 585296 A.10 | 586333 A.14 | 586956 A.18 | 587189 A.16 | 587464 A.18 | 587704 A.18 | |
| 510712 A.10 | 584119 A.27 | 584692 A.8 | 585297 A.11 | 586334 A.14 | 586957 A.18 | 587190 A.16 | 587465 A.18 | 587705 A.16 | |
| 510713 A.10 | 584120 A.27 | 584693 A.8 | 585299 A.11 | 586340 A.14 | 586958 A.18 | 587191 A.16 | 587467 A.18 | 587706 A.18 | |
| 510714 A.10 | 584121 A.27 | 584695 A.8 | 585300 A.10 | 586341 A.14 | 586962 A.18 | 587192 A.16 | 587468 A.18 | 587707 A.16 | |
| 510715 A.10 | 584122 A.27 | 584697 A.8 | 585301 A.10 | 586342 A.14 | 586963 A.16 | 587194 A.18 | 587469 A.18 | 587708 A.18 | |
| 582... | 584123 A.27 | 584698 A.8 | 585543 A.11 | 586343 A.14 | 586964 A.18 | 587195 A.16 | 587470 A.18 | 587709 A.18 | |
| 582065 A.8 | 584124 A.27 | 584699 A.8 | 585548 A.10 | 586344 A.14 | 586983 A.18 | 587196 A.16 | 587484 A.16 | 587710 A.18 | |
| 582066 A.8 | 584130 A.27 | 584700 A.8 | 585550 A.10 | 586350 A.14 | 586985 A.16 | 587200 A.18 | 587485 A.16 | 587714 A.18 | |
| 582067 A.8 | 584140 A.27 | 584701 A.8 | 585551 A.10 | 586351 A.14 | 586986 A.16 | 587201 A.18 | 587486 A.16 | 587719 A.18 | |
| 582070 A.8 | 584141 A.27 | 584702 A.8 | 585563 A.10 | 586352 A.14 | 586987 A.16 | 587202 A.16 | 587487 A.16 | 587735 A.16 | |
| 582071 A.8 | 584151 A.27 | 584703 A.8 | 585604 A.11 | 586353 A.14 | 586988 A.16 | 587203 A.16 | 587488 A.16 | 587736 A.16 | |
| 582073 A.8 | 584152 A.27 | 584704 A.8 | 585606 A.11 | 586354 A.14 | 586989 A.16 | 587204 A.18 | 587489 A.16 | 587737 A.16 | |
| 582074 A.8 | 584153 A.27 | 584710 A.8 | 585743 A.11 | 586360 A.14 | 586990 A.16 | 587205 A.16 | 587490 A.18 | 587738 A.16 | |
| 582076 A.8 | 584154 A.27 | 584711 A.8 | 585748 A.10 | 586361 A.14 | 586991 A.16 | 587206 A.18 | 587491 A.16 | 587739 A.16 | |
| 582077 A.8 | 584155 A.27 | 584712 A.8 | 585750 A.10 | 586362 A.14 | 586992 A.16 | 587207 A.18 | 587492 A.16 | 587740 A.16 | |
| 582078 A.8 | 584162 A.27 | 584713 A.8 | 585751 A.10 | 586363 A.14 | 586993 A.16 | 587208 A.18 | 587493 A.16 | 587741 A.16 | |
| 582079 A.8 | 584163 A.27 | 584714 A.8 | 585803 A.10 | 586364 A.14 | 586994 A.18 | 587212 A.18 | 587494 A.18 | 587743 A.16 | |
| 582080 A.8 | 584164 A.27 | 584715 A.8 | 585804 A.11 | 586370 A.14 | 586995 A.16 | 587213 A.16 | 587496 A.18 | 587744 A.18 | |
| 582085 A.8 | 584165 A.27 | 584716 A.8 | 585806 A.11 | 586371 A.14 | 586996 A.16 | 587214 A.18 | 587497 A.16 | 587745 A.16 | |
| 582086 A.8 | 584166 A.27 | 584717 A.8 | 586... | 586372 A.14 | 587... | 587235 A.16 | 587514 A.9 | 587746 A.16 | |
| 582092 A.8 | 584167 A.27 | 584718 A.8 | 586001 A.11 | 586373 A.14 | 587050 A.18 | 587236 A.16 | 587600 A.18 | 587750 A.14 | |
| 582093 A.8 | 584168 A.27 | 584751 A.8 | 586030 A.9 | 586374 A.14 | 587051 A.18 | 587237 A.16 | 587602 A.18 | 587751 A.14 | |
| 582095 A.8 | 584169 A.27 | 584752 A.8 | 586032 A.9 | 586380 A.14 | 587052 A.16 | 587238 A.16 | 587603 A.18 | 587752 A.14 | |
| 582500 A.28 | 584300 A.27 | 584753 A.8 | 586034 A.9 | 586381 A.14 | 587053 A.16 | 587239 A.16 | 587604 A.18 | 587753 A.14 | |
| 582501 A.28 | 584301 A.27 | 584754 A.8 | 586036 A.9 | 586382 A.14 | 587054 A.18 | 587240 A.16 | 587605 A.18 | 587754 A.14 | |
| 582505 A.29 | 584303 A.27 | 584755 A.8 | 586037 A.9 | 586383 A.14 | 587055 A.16 | 587241 A.16 | 587610 A.18 | 587780 A.16 | |
| 582510 A.28 | 584304 A.27 | 584758 A.8 | 586038 A.9 | 586384 A.14 | 587056 A.18 | 587242 A.16 | 587611 A.16 | 588... | |
| 582511 A.29 | 584520 A.31 | 584759 A.8 | 586039 A.9 | 586390 A.14 | 587057 A.18 | 587244 A.18 | 587612 A.18 | 588014 A.23 | |
| 582512 A.28 | 584521 A.31 | 584762 A.8 | 586041 A.10 | 586391 A.14 | 587058 A.18 | 587245 A.16 | 587613 A.16 | 588015 A.23 | |
| 582515 A.28 | 584522 A.31 | 584763 A.8 | 586042 A.9 | 586392 A.14 | 587062 A.18 | 587246 A.16 | 587614 A.18 | 588016 A.23 | |
| 582520 A.28 | 584523 A.31 | 584764 A.8 | 586052 A.10 | 586393 A.14 | 587063 A.16 | 587250 A.18 | 587615 A.16 | 588017 A.23 | |
| 582531 A.29 | 584527 A.31 | 584765 A.8 | 586053 A.10 | 586394 A.14 | 587064 A.18 | 587251 A.18 | 587616 A.16 | 588018 A.23 | |
| 582533 A.29 | 584535 A.31 | 584766 A.8 | 586055 A.10 | 586400 A.14 | 587083 A.18 | 587252 A.16 | 587617 A.18 | 588021 A.23 | |
| 582537 A.29 | 584537 A.31 | 584767 A.8 | 586074 A.11 | 586411 A.14 | 587085 A.16 | 587253 A.16 | 587618 A.18 | 588022 A.23 | |
| 582541 A.29 | 584539 A.31 | 584768 A.8 | 586086 A.11 | 586412 A.14 | 587086 A.16 | 587254 A.18 | 587619 A.16 | 588023 A.23 | |
| 582543 A.29 | 584541 A.31 | 584769 A.8 | 586091 A.11 | 586413 A.14 | 587087 A.16 | 587255 A.16 | 587628 A.18 | 588024 A.23 | |
| 582545 A.29 | 584543 A.31 | 584770 A.8 | 586095 A.10 | 586414 A.14 | 587088 A.16 | 587256 A.18 | 587630 A.18 | 588025 A.23 | |
| 582550 A.29 | 584544 A.31 | 584772 A.8 | 586096 A.10 | 586420 A.14 | 587089 A.16 | 587257 A.18 | 587631 A.18 | 588026 A.23 | |
| 582551 A.29 | 584550 A.30 | 584773 A.8 | 586097 A.10 | 586421 A.14 | 587090 A.16 | 587258 A.18 | 587632 A.18 | 588027 A.24 | |
| 582552 A.29 | 584551 A.30 | 584780 A.8 | 586098 A.10 | 586422 A.14 | 587091 A.16 | 587262 A.18 | 587633 A.18 | 588028 A.24 | |
| 582553 A.29 | 584552 A.30 | 584781 A.8 | 586103 A.10 | 586423 A.14 | 587092 A.16 | 587263 A.16 | 587634 A.16 | 588029 A.24 | |
| 582554 A.29 | 584553 A.31 | 584782 A.8 | 586105 A.11 | 586424 A.14 | 587093 A.16 | 587264 A.18 | 587635 A.16 | 588030 A.24 | |
| 582555 A.29 | 584554 A.31 | 584783 A.8 | 586107 A.10 | 586430 A.14 | 587094 A.18 | 587285 A.16 | 587636 A.18 | 588031 A.24 | |
| 582560 A.29 | 584555 A.30 | 584784 A.8 | 586108 A.10 | 586431 A.14 | 587095 A.16 | 587286 A.16 | 587637 A.18 | 588032 A.24 | |
| 582601 A.28 | 584557 A.30 | 584785 A.8 | 586109 A.10 | 586432 A.14 | 587096 A.16 | 587287 A.16 | 587638 A.18 | 588033 A.24 | |
| 582602 A.28 | 584558 A.30 | 584786 A.8 | 586110 A.14 | 586433 A.14 | 587100 A.18 | 587288 A.16 | 587639 A.18 | 588034 A.25 | |
| 582603 A.28 | 584559 A.30 | 584787 A.8 | 586112 A.14 | 586434 A.14 | 587101 A.18 | 587289 A.16 | 587640 A.18 | 588035 A.25 | |
| 582604 A.28 | 584561 A.31 | 584788 A.8 | 586115 A.14 | 586508 A.11 | 587102 A.16 | 587290 A.16 | 587641 A.18 | 588036 A.25 | |
| 582609 A.28 | 584562 A.30 | 585... | 586118 A.14 | 586544 A.10 | 587103 A.16 | 587291 A.16 | 587655 A.16 | 588037 A.24 | |
| 582612 A.28 | 584563 A.31 | 585104 A.11 | 586121 A.14 | 586546 A.10 | 587104 A.18 | 587292 A.16 | 587656 A.16 | 588045 A.25 | |
| 582614 A.28 | 584564 A.31 | 585107 A.11 | 586201 A.11 | 586608 A.11 | 587105 A.16 | 587294 A.18 | 587657 A.16 | 588046 A.25 | |
| 582616 A.28 | 584565 A.30 | 585126 A.11 | 586230 A.9 | 586744 A.10 | 587106 A.18 | 587295 A.16 | 587658 A.16 | 588047 A.25 | |
| 582619 A.29 | 584566 A.30 | 585130 A.11 | 586232 A.9 | 586746 A.10 | 587107 A.18 | 587296 A.16 | 587659 A.16 | 588048 A.25 | |
| 582624 A.29 | 584567 A.31 | 585135 A.10 | 586234 A.9 | 586900 A.18 | 587108 A.18 | 587400 A.18 | 587660 A.16 | 588049 A.25 | |
| 582626 A.29 | 584568 A.31 | 585136 A.10 | 586236 A.9 | 586901 A.18 | 587112 A.18 | 587402 A.18 | 587661 A.18 | 588064 A.23 | |
| 582627 A.29 | 584569 A.31 | 585137 A.10 | 586237 A.9 | 586902 A.16 | 587113 A.16 | 587403 A.18 | 587662 A.16 | 588065 A.23 | |
| 582628 A.29 | 584570 A.30 | 585138 A.10 | 586238 A.9 | 586903 A.16 | 587114 A.18 | 587419 A.16 | 587663 A.16 | 588066 A.23 | |
| 582629 A.29 | 584571 A.30 | 585140 A.10 | 586239 A.9 | 586904 A.18 | 587135 A.16 | 587420 A.16 | 587664 A.16 | 588067 A.23 | |
| 582642 A.29 | 584572 A.30 | 585151 A.9 | 586241 A.10 | 586905 A.16 | 587136 A.16 | 587421 A.16 | 587665 A.18 | 588068 A.23 | |
| 582645 A.29 | 584574 A.30 | 585152 A.9 | 586242 A.9 | 586906 A.18 | 587137 A.16 | 587422 A.16 | 587666 A.16 | 588071 A.23 | |
| 582650 A.29 | 584577 A.30 | 585153 A.9 | 586250 A.10 | 586907 A.18 | 587138 A.16 | 587423 A.16 | 587667 A.16 | 588072 A.23 | |
| 582652 A.29 | 584578 A.30 | 585154 A.9 | 586252 A.10 | 586908 A.18 | 587139 A.16 | 587424 A.16 | 587668 A.18 | 588073 A.23 | |
| 582655 A.29 | 584579 A.30 | 585155 A.9 | 586253 A.10 | 586912 A.18 | 587140 A.16 | 587425 A.16 | 587669 A.18 | 588074 A.23 | |
| 582660 A.29 | 584581 A.30 | 585156 A.9 | 586255 A.10 | 586913 A.16 | 587141 A.16 | 587427 A.16 | 587670 A.18 | 588075 A.23 | |
| 582680 A.29 | 584582 A.30 | 585158 A.9 | 586274 A.11 | 586914 A.18 | 587142 A.16 | 587428 A.18 | 587671 A.18 | 588076 A.23 | |
| 584... | 584583 A.30 | 585160 A.10 | 586286 A.11 | 586933 A.18 | 587144 A.18 | 587429 A.16 | 587672 A.18 | 588077 A.24 | |
| 584100 A.27 | 584585 A.31 | 585161 A.10 | 586291 A.11 | 586935 A.16 | 587145 A.16 | 587430 A.18 | 587673 A.16 | 588078 A.24 | |
| 584101 A.27 | 584586 A.31 | 585162 A.10 | 586295 A.10 | 586936 A.16 | 587146 A.16 | 587431 A.16 | 587687 A.16 | 588079 A.24 | |
| 584102 A.27 | 584587 A.31 | 585164 A.10 | 586296 A.10 | 586937 A.16 | 587150 A.18 | 587432 A.16 | 587688 A.16 | 588080 A.24 | |
| 584103 A.27 | 584588 A.31 | 585166 A.11 | 586297 A.10 | 586938 A.16 | 587151 A.18 | 587434 A.18 | 587689 A.16 | 588081 A.24 | |
| 584104 A.27 | 584592 A.31 | 585169 A.11 | 586298 A.10 | 586939 A.16 | 587152 A.16 | 587435 A.18 | 587690 A.16 | 588082 A.24 | |
| 584105 A.27 | 584593 A.31 | 585173 A.10 | 586303 A.10 | 586940 A.16 | 587153 A.16 | 587436 A.18 | 587691 A.16 | 588083 A.24 | |
| 584106 A.27 | 584594 A.31 | 585176 A.10 | 586305 A.11 | 586941 A.16 | 587154 A.18 | 587438 A.16 | 587692 A.16 | 588084 A.25 | |
| 584107 A.27 | 584595 A.31 | 585177 A.10 | 586307 A.10 | 586942 A.16 | 587155 A.16 | 587452 A.16 | 587693 A.16 | 588085 A.25 | |
| 584108 A.27 | 584596 A.31 | 585178 A.10 | 586308 A.10 | 586943 A.16 | 587156 A.18 | 587453 A.16 | 587694 A.18 | 588086 A.25 | |
| 584109 A.27 | 584597 A.31 | 585228 A.9 | 586309 A.10 | 586944 A.18 | 587157 A.18 | 587454 A.16 | 587695 A.16 | 588087 A.24 | |
| 584110 A.27 | 584598 A.31 | 585229 A.9 | 586310 A.14 | 586945 A.16 | 587158 A.18 | 587455 A.16 | 587696 A.16 | 588095 A.25 | |
| 584111 A.27 | 584623 A.31 | 585230 A.9 | 586312 A.14 | 586946 A.16 | 587162 A.18 | 587456 A.16 | 587697 A.18 | 588096 A.25 | |
| 584112 A.27 | 584624 A.31 | 585231 A.9 | 586315 A.14 | 586950 A.18 | 587163 A.16 | 587457 A.16 | 587698 A.16 | 588097 A.25 | |
| 584113 A.27 | 584625 A.31 | 585232 A.9 | 586318 A.14 | 586951 A.18 | 587164 A.18 | 587459 A.16 | 587699 A.16 | 588098 A.25 | |
| 584114 A.27 | 584682 A.8 | 585286 A.10 | 586321 A.14 | 586952 A.16 | 587185 A.16 | 587460 A.16 | 587700 A.18 | 588099 A.25 | |
| 584115 A.27 | 584683 A.8 | 585288 A.10 | 586330 A.14 | 586953 A.16 | 587186 A.16 | 587461 A.16 | 587701 A.16 | 588114 A.23 | |



| Ref. No. | Page | Ref. No. | Page | Ref. No. | Page | Ref. No. | Page | Ref. No. | Page | Ref. No. | Page | Ref. No. | Page | Ref. No. | Page |
|----------|------|----------|------|----------|------|----------|------|----------|------|----------|------|----------|------|----------|------|
| 588115 | A.23 | 588266 | A.16 | 589071 | A.16 | 589252 | A.14 | 589431 | A.16 | 589692 | A.22 | 589863 | A.23 | 600340 | B.6 |
| 588116 | A.23 | 588267 | A.16 | 589080 | A.14 | 589253 | A.14 | 589432 | A.16 | 589693 | A.22 | 589864 | A.22 | 600341 | B.6 |
| 588117 | A.23 | 588268 | A.16 | 589081 | A.14 | 589254 | A.14 | 589440 | A.14 | 589694 | A.22 | 589870 | A.23 | 600342 | B.6 |
| 588118 | A.23 | 588271 | A.16 | 589082 | A.14 | 589255 | A.14 | 589441 | A.14 | 589695 | A.22 | 589871 | A.23 | 600343 | B.6 |
| 588121 | A.23 | 588272 | A.16 | 589083 | A.14 | 589261 | A.14 | 589442 | A.14 | 589700 | A.22 | 589872 | A.23 | 600344 | B.6 |
| 588122 | A.23 | 588273 | A.16 | 589084 | A.14 | 589262 | A.14 | 589443 | A.14 | 589701 | A.23 | 589895 | A.14 | 600345 | B.5 |
| 588123 | A.23 | 588274 | A.16 | 589090 | A.14 | 589263 | A.14 | 589444 | A.14 | 589702 | A.23 | 589910 | A.16 | 600501 | D.6 |
| 588124 | A.23 | 588275 | A.16 | 589091 | A.14 | 589264 | A.14 | 589450 | A.14 | 589703 | A.23 | 589911 | A.16 | 600502 | D.6 |
| 588125 | A.23 | 588276 | A.16 | 589092 | A.14 | 589270 | A.16 | 589451 | A.14 | 589704 | A.22 | 589912 | A.16 | 600503 | B.11 |
| 588126 | A.23 | 588277 | A.18 | 589093 | A.14 | 589271 | A.16 | 589452 | A.14 | 589710 | A.23 | 589915 | A.14 | 600504 | B.11 |
| 588127 | A.24 | 588278 | A.18 | 589094 | A.14 | 589272 | A.16 | 589453 | A.14 | 589711 | A.23 | 589916 | A.14 | 600505 | D.6 |
| 588128 | A.24 | 588279 | A.16 | 589095 | A.14 | 589280 | A.14 | 589454 | A.14 | 589712 | A.23 | 589917 | A.14 | 600506 | D.6 |
| 588129 | A.24 | 588280 | A.16 | 589100 | A.14 | 589281 | A.14 | 589455 | A.14 | 589720 | A.22 | 589918 | A.14 | 600507 | D.6 |
| 588130 | A.24 | 588281 | A.18 | 589101 | A.14 | 589282 | A.14 | 589461 | A.14 | 589721 | A.22 | 589919 | A.14 | 600509 | D.6 |
| 588131 | A.24 | 588282 | A.18 | 589102 | A.14 | 589283 | A.14 | 589462 | A.14 | 589722 | A.22 | 589920 | A.14 | 600514 | D.5 |
| 588132 | A.24 | 588283 | A.18 | 589103 | A.14 | 589284 | A.14 | 589463 | A.14 | 589723 | A.22 | 589921 | A.14 | 600515 | D.5 |
| 588133 | A.24 | 588284 | A.18 | 589104 | A.14 | 589290 | A.14 | 589464 | A.14 | 589724 | A.22 | 589922 | A.14 | 600516 | D.6 |
| 588134 | A.25 | 588285 | A.18 | 589110 | A.16 | 589291 | A.14 | 589470 | A.16 | 589730 | A.22 | 589923 | A.14 | 600517 | D.5 |
| 588135 | A.25 | 588286 | A.18 | 589111 | A.16 | 589292 | A.14 | 589471 | A.16 | 589731 | A.23 | 589924 | A.14 | 600523 | D.5 |
| 588136 | A.25 | 588287 | A.18 | 589112 | A.16 | 589293 | A.14 | 589472 | A.16 | 589732 | A.22 | 589925 | A.14 | 600524 | D.5 |
| 588137 | A.24 | 588295 | A.14 | 589120 | A.14 | 589294 | A.14 | 589480 | A.14 | 589733 | A.22 | 589926 | A.14 | 600525 | D.6 |
| 588145 | A.25 | 588296 | A.14 | 589121 | A.14 | 589295 | A.14 | 589481 | A.14 | 589734 | A.22 | 589927 | A.14 | 600526 | D.6 |
| 588146 | A.25 | 588297 | A.14 | 589122 | A.14 | 589300 | A.14 | 589482 | A.14 | 589735 | A.22 | 589928 | A.14 | 600532 | D.5 |
| 588147 | A.25 | 588298 | A.14 | 589123 | A.14 | 589301 | A.14 | 589483 | A.14 | 589740 | A.22 | 589929 | A.14 | 600539 | D.5 |
| 588148 | A.25 | 588299 | A.14 | 589124 | A.14 | 589302 | A.14 | 589484 | A.14 | 589741 | A.23 | 589931 | A.18 | 600543 | D.5 |
| 588149 | A.25 | 588314 | A.16 | 589130 | A.14 | 589303 | A.14 | 589490 | A.14 | 589742 | A.23 | 589932 | A.18 | 600544 | D.6 |
| 588164 | A.23 | 588315 | A.16 | 589131 | A.14 | 589304 | A.14 | 589491 | A.14 | 589743 | A.23 | 589933 | A.18 | 600545 | D.6 |
| 588165 | A.23 | 588316 | A.16 | 589132 | A.14 | 589311 | A.16 | 589492 | A.14 | 589744 | A.22 | 589934 | A.18 | 600602 | B.3 |
| 588166 | A.23 | 588317 | A.16 | 589133 | A.14 | 589312 | A.16 | 589493 | A.14 | 589750 | A.23 | 589935 | A.18 | 600603 | B.2 |
| 588167 | A.23 | 588318 | A.16 | 589134 | A.14 | 589320 | A.14 | 589494 | A.14 | 589751 | A.23 | 589936 | A.18 | 600604 | B.2 |
| 588168 | A.23 | 588321 | A.16 | 589135 | A.14 | 589321 | A.14 | 589495 | A.14 | 589752 | A.23 | 589937 | A.18 | 600617 | B.2 |
| 588171 | A.23 | 588322 | A.16 | 589140 | A.14 | 589322 | A.14 | 589500 | A.14 | 589760 | A.22 | 589938 | A.18 | 600620 | B.2 |
| 588172 | A.23 | 588323 | A.16 | 589141 | A.14 | 589323 | A.14 | 589501 | A.14 | 589761 | A.22 | 589939 | A.18 | 600621 | B.2 |
| 588173 | A.23 | 588324 | A.16 | 589142 | A.14 | 589324 | A.14 | 589502 | A.14 | 589762 | A.22 | 589940 | A.18 | 600650 | D.3 |
| 588174 | A.23 | 588325 | A.16 | 589143 | A.14 | 589330 | A.14 | 589503 | A.14 | 589763 | A.22 | 589941 | A.18 | 600651 | D.3 |
| 588175 | A.23 | 588326 | A.16 | 589144 | A.14 | 589331 | A.14 | 589504 | A.14 | 589764 | A.22 | 589942 | A.18 | 600652 | D.3 |
| 588176 | A.23 | 588327 | A.18 | 589150 | A.16 | 589332 | A.14 | 589510 | A.16 | 589770 | A.22 | 589943 | A.18 | 600656 | D.3 |
| 588177 | A.24 | 588328 | A.18 | 589151 | A.16 | 589333 | A.14 | 589511 | A.16 | 589771 | A.23 | 589944 | A.18 | 600760 | B.11 |
| 588178 | A.24 | 588329 | A.16 | 589152 | A.16 | 589334 | A.14 | 589512 | A.16 | 589772 | A.22 | 589945 | A.18 | 600762 | B.10 |
| 588179 | A.24 | 588330 | A.16 | 589160 | A.14 | 589335 | A.14 | 589600 | A.14 | 589773 | A.22 | 589946 | A.24 | 600763 | B.10 |
| 588180 | A.24 | 588331 | A.18 | 589161 | A.14 | 589340 | A.14 | 589601 | A.14 | 589774 | A.22 | 589947 | A.24 | 600764 | B.11 |
| 588181 | A.24 | 588332 | A.18 | 589162 | A.14 | 589341 | A.14 | 589602 | A.14 | 589775 | A.22 | 589948 | A.24 | 600765 | B.10 |
| 588182 | A.24 | 588333 | A.18 | 589163 | A.14 | 589342 | A.14 | 589603 | A.14 | 589780 | A.22 | 589949 | A.24 | 600766 | B.10 |
| 588183 | A.24 | 588334 | A.18 | 589164 | A.14 | 589343 | A.14 | 589604 | A.14 | 589781 | A.23 | 589950 | A.24 | 600767 | B.11 |
| 588184 | A.25 | 588335 | A.18 | 589170 | A.14 | 589344 | A.14 | 589610 | A.14 | 589782 | A.23 | 598310 | A.16 | 600769 | B.11 |
| 588185 | A.25 | 588336 | A.18 | 589171 | A.14 | 589350 | A.16 | 589611 | A.14 | 589783 | A.23 | 600... | | 600770 | B.11 |
| 588185 | A.25 | 588337 | A.18 | 589172 | A.14 | 589351 | A.16 | 589612 | A.14 | 589784 | A.22 | 600006 | B.5 | 600783 | B.8 |
| 588186 | A.25 | 588345 | A.14 | 589173 | A.14 | 589352 | A.16 | 589613 | A.14 | 589790 | A.23 | 600007 | B.5 | 600784 | B.8 |
| 588187 | A.24 | 588346 | A.14 | 589174 | A.14 | 589360 | A.14 | 589614 | A.14 | 589791 | A.23 | 600009 | B.5 | 600785 | B.8 |
| 588195 | A.25 | 588347 | A.14 | 589175 | A.14 | 589361 | A.14 | 589615 | A.14 | 589792 | A.23 | 600011 | B.5 | 600786 | B.9 |
| 588196 | A.25 | 588348 | A.14 | 589180 | A.14 | 589362 | A.14 | 589620 | A.14 | 589800 | A.22 | 600013 | B.5 | 600787 | B.9 |
| 588197 | A.25 | 588349 | A.14 | 589181 | A.14 | 589363 | A.14 | 589621 | A.14 | 589801 | A.22 | 600015 | B.5 | 600788 | B.9 |
| 588198 | A.25 | 588370 | A.16 | 589182 | A.14 | 589364 | A.14 | 589622 | A.14 | 589802 | A.22 | 600017 | B.5 | 600789 | B.8 |
| 588199 | A.25 | 588375 | A.16 | 589183 | A.14 | 589370 | A.14 | 589623 | A.14 | 589803 | A.22 | 600019 | B.5 | 600790 | B.8 |
| 588214 | A.23 | 588380 | A.16 | 589184 | A.14 | 589371 | A.14 | 589624 | A.14 | 589804 | A.22 | 600021 | B.5 | 600791 | B.8 |
| 588215 | A.23 | 588851 | A.9 | 589190 | A.16 | 589372 | A.14 | 589630 | A.16 | 589810 | A.22 | 600023 | B.5 | 600792 | B.9 |
| 588216 | A.23 | 588852 | A.9 | 589191 | A.16 | 589373 | A.14 | 589631 | A.16 | 589811 | A.23 | 600025 | B.6 | 600793 | B.9 |
| 588217 | A.23 | 588853 | A.9 | 589192 | A.16 | 589374 | A.14 | 589632 | A.16 | 589812 | A.22 | 600027 | B.6 | 600794 | B.9 |
| 588218 | A.23 | 588854 | A.9 | 589200 | A.14 | 589375 | A.14 | 589640 | A.14 | 589813 | A.22 | 600037 | B.6 | 600795 | B.8 |
| 588221 | A.23 | 588855 | A.9 | 589201 | A.14 | 589380 | A.14 | 589641 | A.14 | 589814 | A.22 | 600039 | B.6 | 600796 | B.8 |
| 588222 | A.23 | 588921 | A.9 | 589202 | A.14 | 589381 | A.14 | 589642 | A.14 | 589815 | A.22 | 600041 | B.6 | 600797 | B.8 |
| 588223 | A.23 | 588922 | A.9 | 589203 | A.14 | 589382 | A.14 | 589643 | A.14 | 589820 | A.22 | 600044 | B.6 | 600798 | B.8 |
| 588224 | A.23 | 588923 | A.9 | 589204 | A.14 | 589383 | A.14 | 589644 | A.14 | 589821 | A.23 | 600046 | B.6 | 600799 | B.9 |
| 588225 | A.23 | 588924 | A.9 | 589210 | A.14 | 589384 | A.14 | 589650 | A.14 | 589822 | A.23 | 600063 | B.5 | 600800 | B.9 |
| 588226 | A.23 | 588925 | A.9 | 589211 | A.14 | 589390 | A.16 | 589651 | A.14 | 589823 | A.23 | 600300 | C.5 | 600882 | C.2 |
| 588227 | A.24 | 589... | | 589212 | A.14 | 589391 | A.16 | 589652 | A.14 | 589824 | A.22 | 600301 | C.5 | 600883 | C.2 |
| 588228 | A.24 | 589040 | A.14 | 589213 | A.14 | 589392 | A.16 | 589653 | A.14 | 589830 | A.23 | 600302 | C.5 | 600884 | C.2 |
| 588229 | A.24 | 589041 | A.14 | 589214 | A.14 | 589400 | A.14 | 589654 | A.14 | 589831 | A.23 | 600306 | C.5 | 600885 | C.2 |
| 588230 | A.24 | 589042 | A.14 | 589215 | A.14 | 589401 | A.14 | 589655 | A.14 | 589832 | A.23 | 600307 | C.5 | 600886 | C.2 |
| 588231 | A.24 | 589043 | A.14 | 589220 | A.14 | 589402 | A.14 | 589660 | A.14 | 589840 | A.22 | 600309 | C.5 | 600887 | C.2 |
| 588232 | A.24 | 589044 | A.14 | 589221 | A.14 | 589403 | A.14 | 589661 | A.14 | 589841 | A.22 | 600310 | D.3 | | |
| 588233 | A.24 | 589050 | A.14 | 589222 | A.14 | 589404 | A.14 | 589662 | A.14 | 589842 | A.22 | 600311 | D.3 | | |
| 588234 | A.25 | 589051 | A.14 | 589223 | A.14 | 589410 | A.14 | 589663 | A.14 | 589843 | A.22 | 600328 | B.3 | | |
| 588235 | A.25 | 589052 | A.14 | 589224 | A.14 | 589411 | A.14 | 589664 | A.14 | 589844 | A.22 | 600329 | B.3 | | |
| 588235 | A.25 | 589053 | A.14 | 589230 | A.16 | 589412 | A.14 | 589670 | A.16 | 589850 | A.22 | 600330 | B.3 | | |
| 588236 | A.25 | 589054 | A.14 | 589231 | A.16 | 589413 | A.14 | 589671 | A.16 | 589851 | A.23 | 600331 | B.3 | | |
| 588237 | A.24 | 589055 | A.14 | 589232 | A.16 | 589414 | A.14 | 589672 | A.16 | 589852 | A.22 | 600332 | B.3 | | |
| 588245 | A.25 | 589060 | A.14 | 589240 | A.14 | 589415 | A.14 | 589680 | A.22 | 589853 | A.22 | 600333 | B.6 | | |
| 588246 | A.25 | 589061 | A.14 | 589241 | A.14 | 589420 | A.14 | 589681 | A.22 | 589854 | A.22 | 600334 | B.6 | | |
| 588247 | A.25 | 589062 | A.14 | 589242 | A.14 | 589421 | A.14 | | | | | | | | |

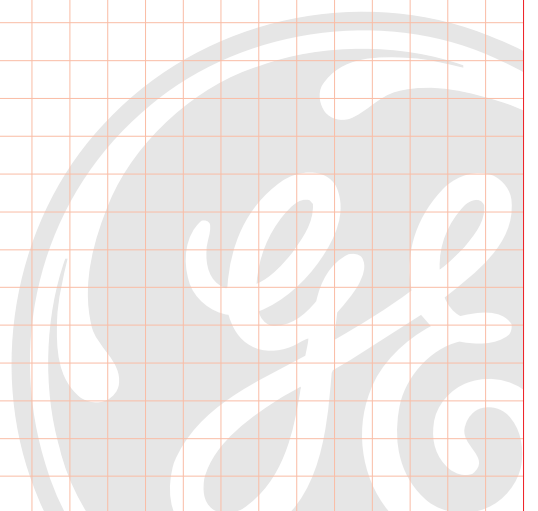

GE Consumer & Industrial Power Protection

Power Protection (former GE Power Controls), a division of GE Consumer & Industrial, is a first class European supplier of low-voltage products including wiring devices, residential and industrial electrical distribution components, automation products, enclosures and switchboards. Demand for the company's products comes from wholesalers, installers, panel-board builders, contractors, OEMs and utilities worldwide

www.gepowercontrols.com

GE POWER CONTROLS
International Sales
Nieuwevaart 51
B-9000 Gent - Belgium
Tel. +32/9 265 21 11
Fax +32/9 265 28 90
E-mail: gepcb@gepc.ge.com



GE imagination at work